

GYNEX[®]

Winter 2025



Speculums

SEE PAGES 82-88



Biopsy Punches

SEE PAGES 6-14

Acetic Acid

SEE PAGE 5



Monsel's

SEE PAGE 5

QUALITY

Steve says . . .

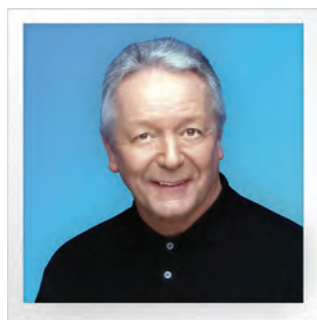

As we step into the promising year of 2025, the team at Gynex extends warm wishes for a Happy New Year filled with joy, health, and prosperity.

We are pleased to present our latest Winter Catalog featuring a comprehensive range of cutting-edge OBGYN instruments tailored to meet the evolving needs of your practice. We recognize the importance of the work you do, and it is an honor to contribute to your success by providing reliable and high-quality instruments. Our team is ready to assist should you

have any inquiries, require personalized assistance, or wish to discuss custom solutions.

Thank you for choosing Gynex as your partner in women's healthcare. We look forward to serving you and being an integral part of your continued success.

Thank you,

A handwritten signature in cursive script that reads "Steve".

Stephen J. Sullivan

President and CEO, GYNEX® Corporation

Stephen J. Sullivan

President and CEO, GYNEX® Corporation

1996 – 1999	International Medical Consultant
1993 – 1995	President, CooperSurgical® International Division
1991 – 1993	President, Euro-Med™ Division of CooperSurgical®
1978 – 1991	Founder and President of Euro-Med®, Inc.

VETERAN OWNED AND OPERATED SINCE 1997



Table of Contents

Best Sellers	2-3	COLPOSCOPES - Galileo®	46-51
Patel™, Multi-Use Forceps	4	Accessories for Galileo® Colposcope	52
Monsel's Ferric Subsulfate Paste	5	Galileo® Biological Microscope	53
Acetic Acid	5	COLPOSCOPES - CO Series	54-59
BIOPSY PUNCHES	6-14	Galileo® Medical Exam Light	60-61
Ceramix™ Biopsy Punch	6	Accessories for Galileo® Medical Exam Light	60
Opal Rainbow™ Biopsy Punch, Titanium	7	Touch-Guard® Single-Use Protective Sheath	61
Amethyst Biopsy Punch, Titanium	8	HYSTERECTOMY CLAMPS - Zephyr™ Titanium Rainbow™	62
Sapphire Biopsy Punch, Titanium	8	HYSTERECTOMY SCISSORS - Titanium Rainbow™ / Zephyr™	63
Gold Biopsy Punch, Titanium	9	NEEDLE HOLDERS - Webster / Mayo Hegar / Crile Wood	64
Rose Gold Biopsy Punch, Titanium	9	Laminaria Insertion Forceps	64
Tischler Biopsy Punch, Stainless	10-11	Electrode Extender / Electrode Handpieces	65
Rotating Biopsy Punches, Stainless - ROTO Tip™	12-13	LLETZ ELECTRODES	66-68
Ring Handle Biopsy Punches, Stainless	14	Electrosurgery Patient Dispersive Pads for LLETZ Procedure	69
Other Biopsy Punches, Stainless	14	Extended Needle Adapter and Accessories	71
TENACULUMS	15-16	Smoke Evacuation Systems (Prefilter, Reducer, and Filter)	72
Tissue Forceps, 1x2 teeth	16	Tubing and Connectors for LLETZ Procedure	73
HOOKS	17	Sponge Forceps, Single-Use ☼	74
ENDOMETRIAL CURETTES	17	Topical Anesthetic - HurriCaine®	74
ENDOCERVICAL CURETTES	18	LLETZ COATED INSTRUMENTS	
Lickrish Spiral Curettes	19	Tenaculum	75
RotoCurette™	19	Hooks	75
ENDOCERVICAL SPECULUM	19	Forceps	75
FOERSTER FORCEPS	19	Rulers	75
OVUM FORCEPS	20-21	4- Way Expander Vaginal Speculum	76
Word Bartholin Catheter Kit	22	Lateral Vaginal Retractor	77
Carson Myoma Polyp Grasping Forceps	22	Open-Sided Speculum	77
KEYES PUNCHES	23	Sullivan Vaginal Speculum	78-79
Patel™, Multi-Use Forceps	24	Pederson & Graves Vaginal Speculum	80-81
IUD SECTION		SPECULUM, STAINLESS STEEL	
CERAMIX™ Coated IUD String Scissors	25	Pederson & Graves Speculum	82-83
IUD String Scissors	25	Sullivan Speculum	84-85
Villa™ Hormonal Dissecting Forceps	26	Lateral Vaginal Retractors	86
Villa™ Hormonal Implant Remover	27	Auvard Weighted Speculum	86
IUD String Scissors, Single-Use	28	Guttman Speculum	87
Alligator Grasper by GYNEX®	28	Greeberg Hysteroscopy Speculum	87
Serpentine Grasper	28	Open-Sided Speculum	88
IUD Removers	29	Titanium Rainbow™ Speculum	89
Ascona® IUD Snare	30	Fetal Doppler / Doppler Gel / Thermasonic Gel Warmer	90
IUD Insertion Kit - GYNEX®, Single-Use ☼	30	pHem-Alert® Vaginal pH test	91
UTERINE SOUNDS		Instrument Care and Cleaning	
Accu-Sound®	31	Hot Glass Beads Sterilizer - Touch-Guard®	92
Sims Sound • flex	32	Low Suds Detergent Concentrate - Touch-Guard®	92
Other Sims Sound	32	Stain Ex™ Stain Remover - Touch-Guard®	92
UTERINE DILATORS - Stainless Steel, Soft and Dennis	33-39	Instrument Lubricant - Touch-Guard®	93
UTERINE CURETTES - Sims / Bumm	40	Instrument Repair and Sharpening	93
Uterine Manipulator / Injector - Century UMI™	41	INDEX	95
Endometrial Curette - SURESAMPLE® Select1	42-43	ORDER INFORMATION	96-97
Endometrial Sampler - SURESAMPLE®	44-45	ORDER FORM	97

Best-Sellers

A tall, white, adjustable medical exam light with a flexible gooseneck and a circular control panel on the stem. The light fixture is at the top, and the base is a black four-wheeled cart.

**Galileo®
Medical
Exam Light**
SEE PAGES 60-61

A white colposcope with a long, adjustable neck and a control panel on the base. The eyepieces are at the top, and the base has a black handle and a control panel.

**Galileo®
Colposcope
Direct-Access™**
SEE PAGES 46-51

RotoCurette™

SEE PAGE 19

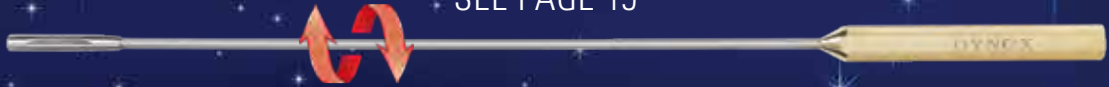

IUD String Scissors

SEE PAGE 25



Patel™ Multi-Use Forceps

SEE PAGES 4, 24



Biopsy Punches

SEE PAGES 6-14



Patel™

Multi-Use Forceps

New

The one instrument that every gynecologist needs in their practice. With its patent-pending design, the **Patel™** excels at multiple functions:

- IUD Remover
- Sponge / Foerster Forceps
- Needle Holder
- Atraumatic Tissue Grasper
- *More!*

REF NHL3450 **\$119⁹⁵**

**The Patel is the
Swiss Army Knife
of Gynecology**

To learn more,
see **page 24**



Monse's Ferric Subsulfate Paste 20-22%

Monse's is a pre-thickened formulation of the popular hemostatic agent. Apply directly to the surgical site following excision of tissue.

- Box of 12 Individual - 8ml vials
- 12 rayon-tipped applicator swabs
- Single-Patient-Use 

REF 5055 Box of 12 **\$199⁹⁵**

Controls bleeding after biopsy, LLETZ and laser procedures.

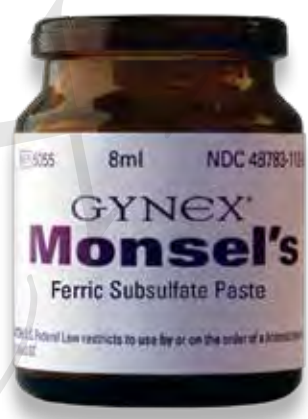

Acetic Acid 5%

- Box of 12 Individual - 12ml vials
- 12 rayon-tipped applicator swabs
- Single-Patient-Use 

REF AA312 Box of 12 **\$89⁹⁵**

Helps enhance the appearance of abnormal areas.





CERAMIX™ Biopsy Punches

Our sharpest, longest lasting biopsy punch

CERAMIX™ coated biopsy punches offer increased resistance to corrosion and resilience against impact and low friction coefficient results on the market. Sharper up to 10 times longer than ordinary stainless steel with incomparable cutting-edge hardness.

See Hardness Comparison Chart below.

Hardness Comparison Chart

METAL	(HV 0.05)	COATED METAL	(HV 0.05)
Stainless Steel	550	Titanium Nitride	2900
Tungsten Carbide	650	CERAMIX Coating	4500

Vickers Hardness Test - HV/0.05 meaning a 50g load was used.



GYNEX®
Original!



CERAMIX™ Mini-Tischler

Actual Bite Size:

4.2mm x 2.3mm

REF 1060

20cm Shaft \$525⁹⁵



CERAMIX™ Medium Tischler

Actual Bite Size:

5mm x 3mm

REF 1065

20cm Shaft \$525⁹⁵



CERAMIX™ Tischler

Actual Bite Size:

7mm x 3mm

REF 1070

20cm Shaft \$525⁹⁵



CERAMIX™ Apex™

Actual Bite Size:

7mm x 3mm

REF 1075

20cm Shaft \$525⁹⁵

Opal Rainbow™ Biopsy Punches, TITANIUM

Exclusive Titanium coated biopsy punches offer increased resistance to corrosion, resilience against impact and low friction coefficient. Stays sharper and smoother longer than traditional stainless steel.

- Double-spring handle



GYNEX®
Original!

OPAL RAINBOW™ Tischler

Actual Bite Size: 7mm x 3mm 

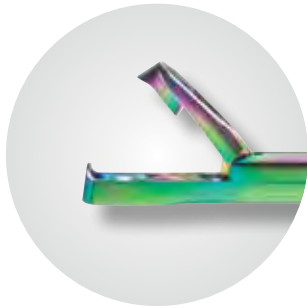

Tischler

REF TT010 20cm Shaft **\$434⁹⁵**

REF TT035

25cm Shaft, Extra-Long **\$444⁹⁵**
bariatric

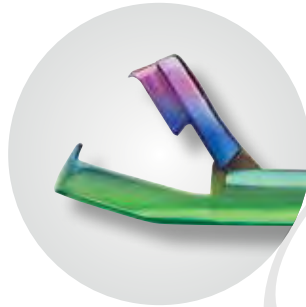

Tischler, Tip Up

REF TT011 20cm Shaft **\$434⁹⁵**

REF TT036

25cm Shaft, Extra-Long **\$444⁹⁵**
bariatric

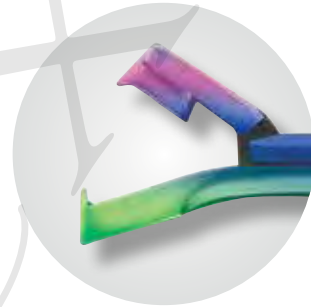

Tischler, Tip Down

REF TT012 20cm Shaft **\$434⁹⁵**

REF TT037

25cm Shaft, Extra-Long **\$444⁹⁵**
bariatric

OPAL RAINBOW™ Mini-Tischler

Actual Bite Size: 4.2mm x 2.3mm 



Mini-Tischler

REF TT005 20cm Shaft **\$434⁹⁵**

REF TT030

25cm Shaft, Extra-Long **\$444⁹⁵**
bariatric

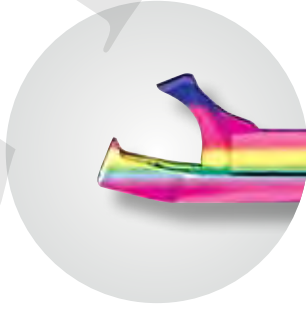

Mini-Tischler, Tip Up

REF TT006 20cm Shaft **\$434⁹⁵**

REF TT031

25cm Shaft, Extra-Long **\$444⁹⁵**
bariatric



Mini-Tischler, Tip Down

REF TT007 20cm Shaft **\$434⁹⁵**

REF TT032

25cm Shaft, Extra-Long **\$444⁹⁵**
bariatric

Amethyst Biopsy Punches, TITANIUM

Designed for excellence • Manufactured for durability



Amethyst Tischler

Actual Bite Size: 7mm x 3mm

REF TA010
20cm Shaft **\$434⁹⁵**



GYNEX[®]
Original!



Amethyst Mini-Tischler

Actual Bite Size: 4.2mm x 2.3mm

REF TA005
20cm Shaft **\$434⁹⁵**

Rose Gold Biopsy Punches, TITANIUM

Designed for excellence • Manufactured for durability



Rose Gold Tischler

Actual Bite Size: 7mm x 3mm

REF PINK010
20cm Shaft **\$434⁹⁵**

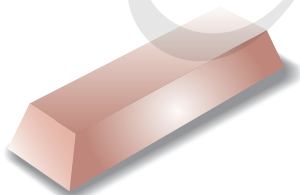

GYNEX[®]
Original!



Rose Gold Mini-Tischler

Actual Bite Size: 4.2mm x 2.3mm

REF PINK005
20cm Shaft **\$434⁹⁵**

Gold Biopsy Punches, TITANIUM

Designed for excellence • Manufactured for durability



Gold Tischler

Actual Bite Size: 7mm x 3mm

REF TAU010

20cm Shaft \$434⁹⁵

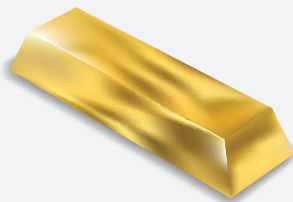

Gold Mini-Tischler

Actual Bite Size: 4.2mm x 2.3mm

REF TAU005

20cm Shaft \$434⁹⁵



GYNEX
Original!

Sapphire Biopsy Punches, TITANIUM

Designed for excellence • Manufactured for durability



Sapphire Tischler

Actual Bite Size: 7mm x 3mm

REF TB010

20cm Shaft \$434⁹⁵

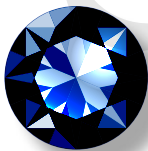

GYNEX
Original!



Sapphire Mini-Tischler

Actual Bite Size: 4.2mm x 2.3mm

REF TB005

20cm Shaft \$434⁹⁵

Tischler Biopsy Punches, STAINLESS



The Best Selling Design in The World

Invented by GYNEX President Stephen J. Sullivan,
the modern Tischler Biopsy Punch is the
#1 Selling Design Worldwide!



GYNEX®
Original!

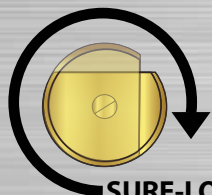

SURE-LOCK

Tip-Locking Thumb Tab



Tischler

Actual Bite Size: 7mm x 3mm 

Tischler

REF 1010 20cm Shaft **\$414⁹⁵**

REF 1035 25cm Shaft, Extra Long... **\$424⁹⁵**
bariatric



Tischler, Tip Up

REF 1012 20cm Shaft **\$414⁹⁵**



Tischler, Tip Down

REF 1014 20cm Shaft **\$414⁹⁵**



Mini-Tischler

Actual Bite Size: 4.2mm x 2.3mm 

Mini-Tischler

REF 1005 20cm Shaft..... **\$414⁹⁵**

REF 1030 25cm Shaft, Extra Long... **\$424⁹⁵**
bariatric



Mini-Tischler, Tip Up

REF 1006 20cm Shaft **\$414⁹⁵**



Mini-Tischler, Tip Down

REF 1007 20cm Shaft **\$414⁹⁵**

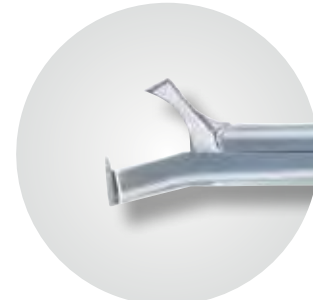



Tischler Kevorkian

Single anchoring tooth on top and bottom jaws

Actual Bite Size: 9mm x 3mm

Tischler-Kevorkian

REF 1015 20cm Shaft \$414⁹⁵

REF 1037 25cm Shaft, Extra Long..... \$424⁹⁵

bariatric



Kevorkian

- Traditional Kevorkian bite
- Four teeth on bottom jaw

Actual Bite Size: 9mm x 3mm

REF 1029 20cm Shaft \$414⁹⁵



Medium Tischler

Actual Bite Size: 5mm x 3mm

Medium Tischler

REF 1008 20cm Shaft \$414⁹⁵

REF 1033 25cm Shaft, Extra Long... \$424⁹⁵

bariatric

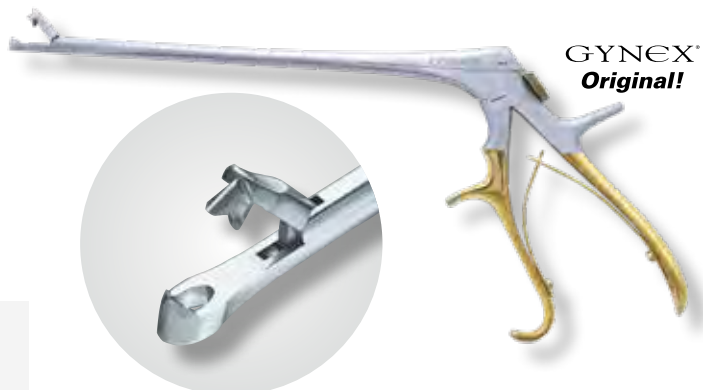

RotoTIP™ Biopsy Punch, STAINLESS



RotoTIP™ rotating biopsy punches offers the added convenience of changing the biopsy tip size and shape without the expense of having additional complete biopsy punches. With a single handle, you can have several tips available. Although the Standard Tip Tischler and the Mini-Tischler are the most popular, this design provides you a cost savings option to add angled tips. These tips easily rotate, allowing you to gain better positioning for a biopsy sample.

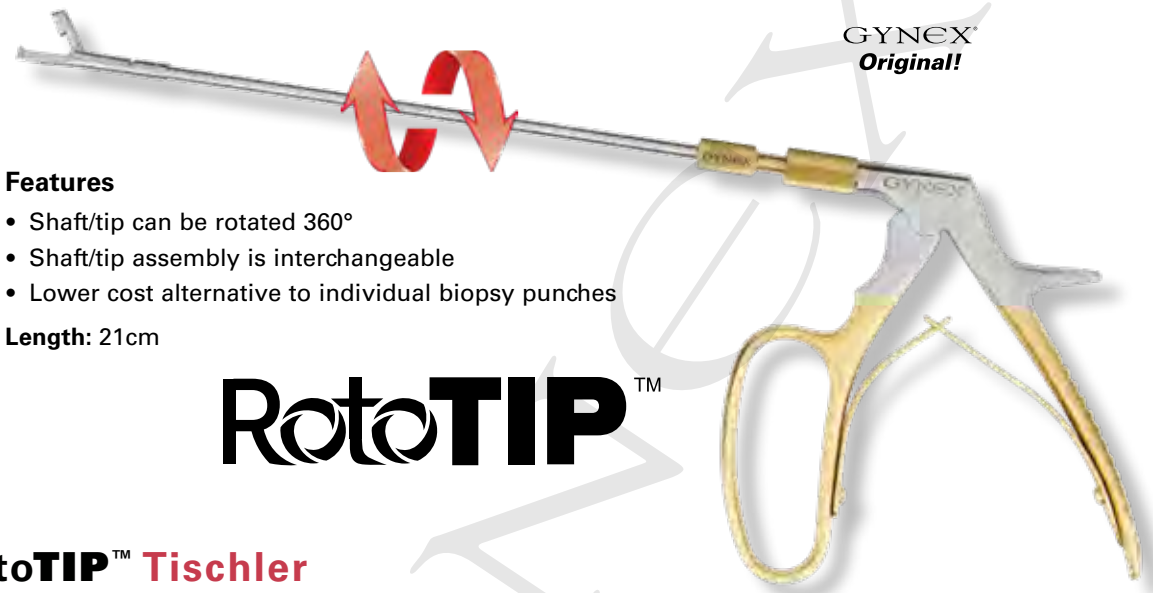

Features

- Shaft/tip can be rotated 360°
- Shaft/tip assembly is interchangeable
- Lower cost alternative to individual biopsy punches

Length: 21cm

RotoTIP™

RotoTIP™ Tischler

Actual Bite Size: 7mm x 3mm 

Tischler

REF 1200-10
Complete Punch \$495⁹⁵

REF 1210
Tip Only \$299⁹⁵

Tischler, Tip-Up

REF 1200-30
Complete Punch \$495⁹⁵

REF 1230
Tip Only \$299⁹⁵

Tischler, Tip-Down

REF 1200-20
Complete Punch \$495⁹⁵

REF 1220
Tip Only \$299⁹⁵

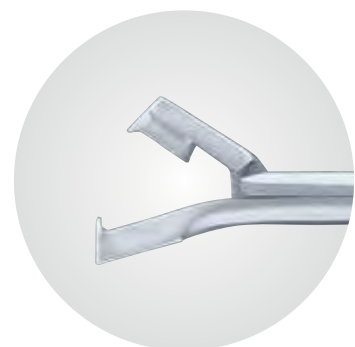

RotoTIP™ Mini-Tischler

Actual Bite Size: 4.2mm x 2.3mm 

Mini-Tischler

REF 1200-05
Complete Punch \$495⁹⁵

REF 1205
Tip Only \$299⁹⁵



Mini-Tischler, Tip-Down

REF 1200-15
Complete Punch \$495⁹⁵

REF 1215
Tip Only \$299⁹⁵



Mini-Tischler, Tip-Up

REF 1200-25
Complete Punch \$495⁹⁵

REF 1225
Tip Only \$299⁹⁵

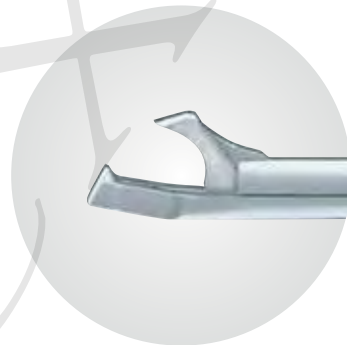

RotoTIP™ Oval

Actual Bite Size: 5mm x 3mm 

Oval Tip

REF 1200-35
Complete Punch \$495⁹⁵

REF 1235
Tip Only \$299⁹⁵



RotoTIP™ Kevorkian

Actual Bite Size: 9mm x 3mm 

Kevorkian Tip

REF 1200-40
Complete Punch \$495⁹⁵

REF 1240
Tip Only \$299⁹⁵



RotoTIP™ Handle

REF 1200
Handle Only \$209⁹⁵



Ring Handle Biopsy Punches, STAINLESS



Sullivan Ring Handle Punch

Excellent for stenotic cervix

- Small handle / Mini tip

Actual Bite Size: 4mm x 2mm 

REF 1050

24cm Shaft \$414⁹⁵



GYNEX[®]
Original!

Kevorkian Ring Handle Punch

- Traditional Kevorkian bite
- Four teeth on bottom jaw

Actual Bite Size: 9mm x 3mm 

REF 1053

25cm Shaft \$414⁹⁵

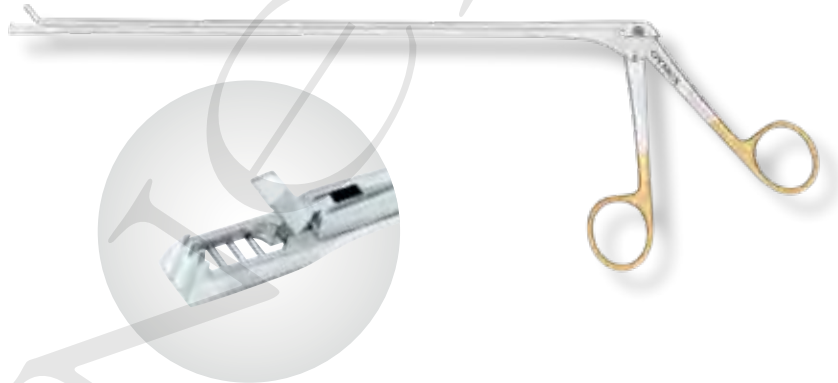

Biopsy Punches, STAINLESS



Apex[™]

V-shaped anchoring jaw on the top and bottom

Actual Bite Size: 7mm x 3mm 

Apex[™]

REF 1025 20cm Shaft \$414⁹⁵

REF 1039 25cm Shaft, Extra Long \$424⁹⁵

bariatric

GYNEX[®]
Original!



Tenaculums

Braun Tenaculum

LiteTouch™ TIP

LiteTouch tips overlap 1-2 mm ±1mm (when closed)



Straight Handle

REF T2230 25cm Length **\$59⁹⁵**

Angled Handle

REF T2235 25cm Length **\$65⁹⁵**

Standard TIP

Standard tips overlap 4-6 mm ±1mm (when closed)



Straight Handle

REF 3502 25cm Length **\$56⁹⁵**

REF B230 30cm Length **\$67⁹⁵**

Angled Handle

REF 3532 25cm Length **\$65⁹⁵**

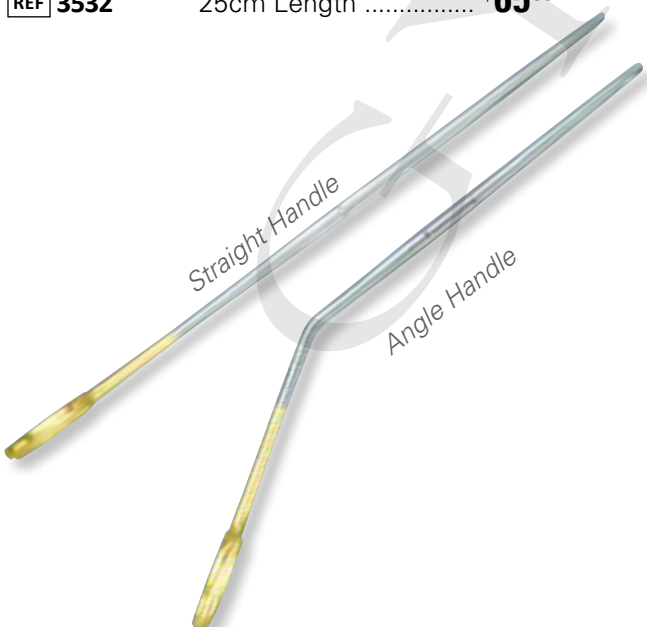

Schroeder Tenaculum

LiteTouch™ TIP

LiteTouch tips overlap 1-2 mm ±1mm (when closed)



Straight Handle

REF T2222 25cm Length **\$59⁹⁵**

Angled Handle

REF T2225 25cm Length **\$65⁹⁵**

Standard TIP

Standard tips overlap 4-6 mm ±1mm (when closed)



Straight Handle

REF 3500 25cm Length **\$56⁹⁵**

REF B130 30cm Length **\$67⁹⁵**

Angled Handle

REF 3530 25cm Length **\$65⁹⁵**

Double Tooth



Straight Handle

REF 3501 Length 25cm **\$65⁹⁵**

Teale Tenaculum

Slight Curve

REF 3536 25cm Length \$56⁹⁵



Skene Tenaculum

Slight Curve

REF 3534 24cm Length \$56⁹⁵



Foerster Forceps



Straight Handle

REF 3540 24cm Length \$56⁹⁵

REF B330 30cm Length \$67⁹⁵

Angled Handle

REF 3542 24cm Length \$65⁹⁵

Tissue Forceps

Hold and manipulate various tissue.

REF S3205 21.5cm Length \$59⁹⁵

REF BTF25 25cm Length \$59⁹⁵

REF BTF30 30cm Length \$59⁹⁵



Endocervical Speculum

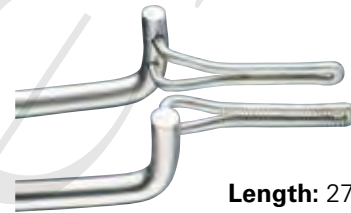

Length: 27cm

Ratchet Handle

REF 2130 3mm Tip \$197⁹⁵

REF 2140 4mm Tip \$197⁹⁵

No Ratchet

REF 2030 3mm Tip \$187⁹⁵

REF 2040 4mm Tip \$187⁹⁵



Hooks

Angle Hook

REF 3225

26cm Length \$49⁹⁵

Iris Hook

REF 3210

26cm Length \$49⁹⁵

2-Prong Hook

REF 3227

26cm Length \$59⁹⁵

Emmett Tenaculum

REF 3220

26cm Length \$49⁹⁵

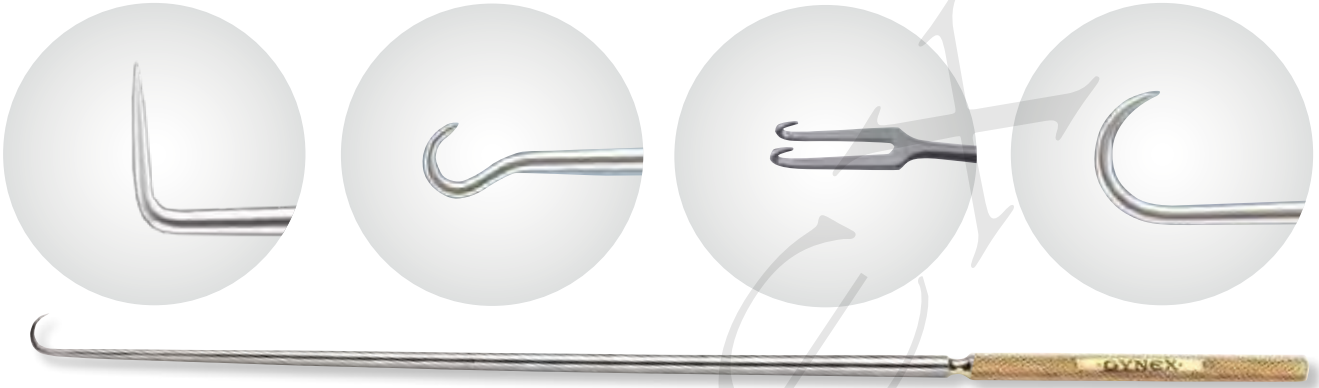

Endometrial Curettes

Novak Curette

- Luer lock suction attachment

Length: 25cm

Shaft/Tip Size: 2mm ●

REF 3302 \$57⁹⁵

Shaft/Tip Size: 3mm ●

REF 3303 \$57⁹⁵

Shaft/Tip Size: 4mm ●

REF 3304 \$57⁹⁵

Randall Curette

- Luer lock suction attachment

Length: 25cm

Shaft/Tip Size: 2mm ●

REF 3310 \$57⁹⁵

Shaft/Tip Size: 3mm ●

REF 3312 \$57⁹⁵

Shaft/Tip Size: 4mm ●

REF 3314 \$57⁹⁵

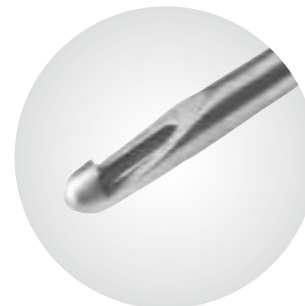

Endocervical Curettes

Kevorkian Curette with Basket Square Tip

Features a basket for secure sample collection during curettage procedures.

Basket Size: 10.5mm x 2mm

REF TC3005

Titanium Rainbow ... **\$86⁹⁵**



REF 3005

Stainless Steel **\$79⁹⁵**



Kevorkian Curette Square Tip

Opening: 12mm x 2mm

REF TC3010

Titanium Rainbow ... **\$86⁹⁵**



REF 3010

Stainless Steel **\$79⁹⁵**



Dublin Curette Round Tip

Provides samples when aggressive scraping is necessary for hard to sample tissue.

Diameter: 4mm

REF TC3025

Titanium Rainbow ... **\$86⁹⁵**



REF 3025

Stainless Steel **\$79⁹⁵**



Kevorkian Curette with Basket Round Tip

Features a basket for secure sample collection and a rounded tip for easier insertion.

Basket Size: 11.5mm x 2mm

REF TC3015

Titanium Rainbow ... **\$86⁹⁵**



REF 3015

Stainless Steel **\$79⁹⁵**

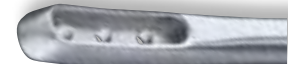

Townsend Curette

Designed with a small, pointed tip to facilitate easier penetration of the os.

Opening: 7mm x 1.3mm

REF TC3020

Titanium Rainbow ... **\$86⁹⁵**



REF 3020

Stainless Steel **\$79⁹⁵**



Curette Sharpening File

A compact, tapered sharpening stone with a diamond coating to maintain your curette's sharpness.

REF CSF3900 **\$34⁹⁵**

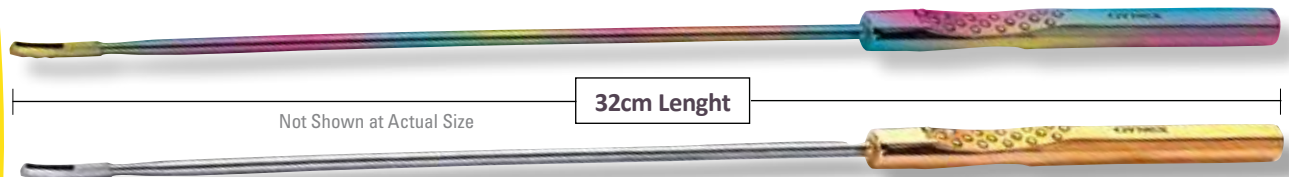

Lickrish Spiral Curettes

Dilator • Curette



The innovative Endocervical Lickrish Spiral Dual-Purpose Curette was developed by Dr. Gordon M Lickrish, former director of the colposcopy unit at University Health Network in Toronto. The spiral design is ideal for addressing cases of severe cervical stenosis and narrow endocervical canals, allowing for gentle insertion, dilation, and precise tissue sampling when standard curettes are inadequate. The tip can be gently guided through the Os while simultaneously advancing and rotating.

Titanium Cobalt

REF TB3040 21cm Length \$86⁹⁵



Titanium Rainbow

REF TC3040 21cm Length \$86⁹⁵



Stainless Steel

REF 3040 21cm Length \$82⁹⁵



RotoCurette™

The RotoCurette ECC is inserted into the canal and rotated to obtain samples from both sides.

REF 3050

Stainless Steel \$82⁹⁵



Kevorkian Curette, Single-Use

Featuring a sharp basket tip and firm, angled handle for stability, leverage, and precise maneuverability during curettage procedures.

REF 3030 Box of 25 \$82⁹⁵

Total Length: 31cm

Inner Basket: 3mm

Working Length: 16cm

OD: 4mm

STERILE EO Single-Use

Not made with natural rubber latex.

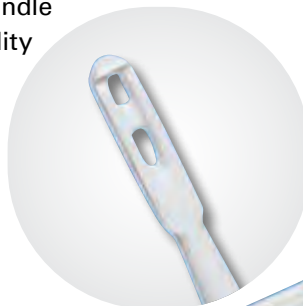

Ovum Forceps

Sopher Ovum Forceps

Sopher Original

Length: 25.5cm (10") Curved Jaw 11mm

REF 3544 Ratchet Handle **\$114⁹⁵**

REF 3546 No Ratchet **\$109⁹⁵**



Sopher Original "lips" protect surrounding tissue



Sopher Jaw
Actual Size: 11mm

Sopher Standard

Length: 25.5cm (10") Curved Jaw 12mm

REF 3548 Ratchet Handle **\$114⁹⁵**

REF 3550 No Ratchet **\$109⁹⁵**



Sopher Original Jaw Open



Sopher Jaw
Actual Size: 12mm

Length: 25.5cm (10") Curved Jaw 14mm

REF 3552 Ratchet Handle **\$119⁹⁵**

REF 3554 No Ratchet **\$114⁹⁵**



Sopher Standard Jaw Closed

Length: 28cm (11") Curved Jaw 12mm

REF 3556 Ratchet Handle **\$114⁹⁵**

REF 3558 No Ratchet **\$109⁹⁵**

Length 28cm (11") Curved Jaw 14mm

REF 3560 Ratchet Handle **\$119⁹⁵**

REF 3562 No Ratchet **\$114⁹⁵**



Sopher Standard Jaw Open



Sopher Jaw
Actual Size: 14mm

Length: 33cm (13") Curved Jaw 12mm

REF 3564 Ratchet Handle **\$124⁹⁵**

REF 3566 No Ratchet **\$119⁹⁵**

Length: 33cm (13") Curved Jaw 14mm

REF 3568 Ratchet Handle **\$129⁹⁵**

REF 3570 No Ratchet **\$124⁹⁵**

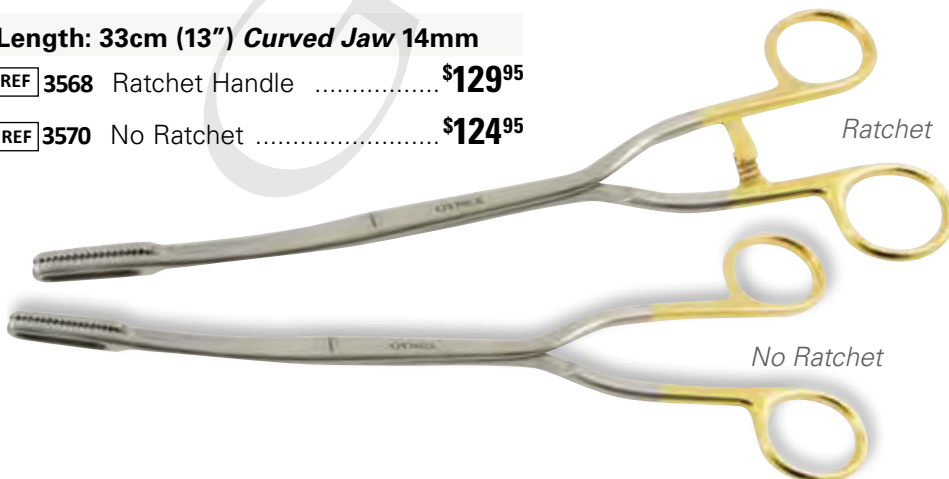

Ratchet

No Ratchet

Bierer Ovum Forceps

Length: 28cm (11") Straight Jaw 16mm

REF 3572 Ratchet Handle \$114⁹⁵

REF 3574 No Ratchet \$109⁹⁵

Length: 28cm (11") Straight Jaw 19mm

REF 3576 Ratchet Handle \$119⁹⁵

REF 3578 No Ratchet \$114⁹⁵

Length: 33cm (13") Straight Jaw 16mm

REF 3580 Ratchet Handle \$119⁹⁵

REF 3582 No Ratchet \$114⁹⁵

Length: 33cm (13") Straight Jaw 19mm

REF 3584 Ratchet Handle \$124⁹⁵

REF 3586 No Ratchet \$119⁹⁵



Bierer, Jaw Open

Jacobson Ovum Forceps

Length: 28cm (11") Straight Jaw 20mm

REF 3588 No Ratchet \$114⁹⁵

Length: 33cm (13") Straight Jaw 20mm

REF 3590 No Ratchet \$114⁹⁵

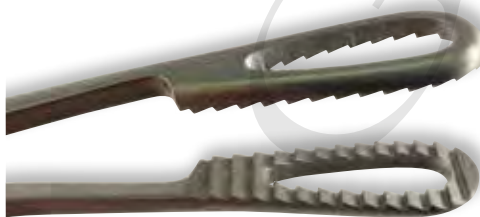

Jacobson, Jaw Open

Blumenthal Ovum Forceps

Length: 28cm (11") Straight Jaw 20mm

REF 3592 No Ratchet \$114⁹⁵

Length: 33cm (13") Straight Jaw 20mm

REF 3594 No Ratchet \$119⁹⁵



*Blumenthal
"lips" protect surrounding tissue*

Saenger Ovum Forceps

Length: 26.5cm (10.5") Straight Jaw 16mm

REF 3596 Ratchet Handle \$114⁹⁵

REF 3598 No Ratchet \$109⁹⁵

Length: 26.5cm (10.5") Curved Jaw 16mm

REF 3600 Ratchet Handle \$114⁹⁵

REF 3602 No Ratchet \$109⁹⁵



Saenger Inner diameter teeth within oval jaws



Blumenthal

Word Bartholin Catheter Kit

STERILE EO Single-Use
 Not made with natural rubber latex.

The Word Bartholin Catheter Kit contains everything you need for an effective office treatment of Bartholin gland abscesses and cysts providing patients with immediate relief.

Each Kit Contains:

- (1) Silicone inflatable catheter
- (1) Scalpel
- (1) 3cc Syringe w/24 GA Needle

REF 10-200 Box of 2 kits **\$59⁹⁵**

Outpatient Treatment for Bartholin gland cysts and abscesses.

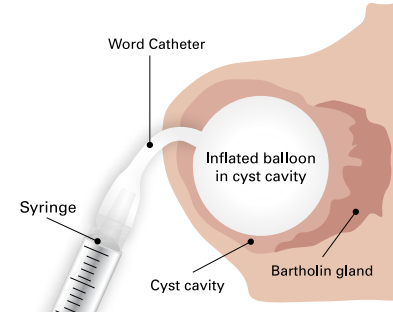

Insertion of an inflatable balloon is a non-surgical procedure that can be performed as an outpatient using a local anaesthetic injection to numb the area. It involves making a passage through which the pus can drain over 4 weeks.



Corson Myoma Polyp Grasping Forceps

Experience precision and reliability with our Polyp Grasping Forceps, designed for superior performance in polyp removal procedures. Engineered with high-quality stainless steel, these forceps ensure exceptional durability and longevity.

Key Features:

- Precision Grip: Fine-tipped design for secure and accurate grasping of polyps.
- Ergonomic Handle: Comfortable, non-slip grip reduces hand fatigue during extended use.
- Enhanced Control: Smooth operation for seamless maneuverability in delicate procedures.

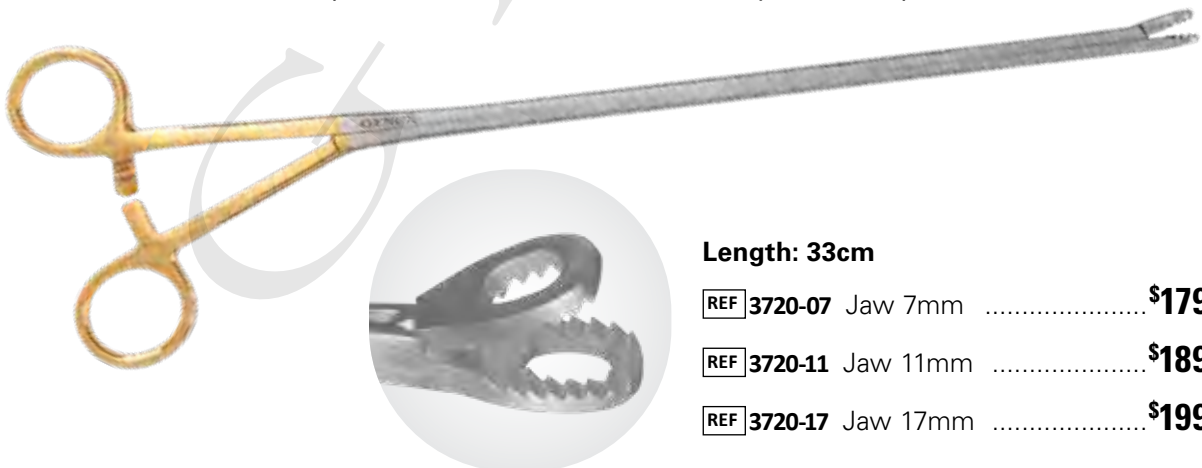

Length: 33cm

- REF 3720-07 Jaw 7mm **\$179⁹⁵**
- REF 3720-11 Jaw 11mm **\$189⁹⁵**
- REF 3720-17 Jaw 17mm **\$199⁹⁵**

Keyes Vulvar Punch

Features a sharpened round tip, ideal for obtaining vertical core samples from the vulvar epithelium. Designed with a sturdy handle specifically for easy ejection of lodged specimens.

● **2mm Tip**

REF 1302 \$49⁹⁵

● **3mm Tip**

REF 1303 \$49⁹⁵

● **4mm Tip**

REF 1304 \$49⁹⁵

● **5mm Tip**

REF 1305 \$49⁹⁵

● **6mm Tip**

REF 1306 \$49⁹⁵

● **7mm Tip**

REF 1307 \$49⁹⁵



Keyes Vulvar Punch Single-Use

STERILE EO Single-Use

Not made with natural rubber latex.

This Single-Use Keyes Vulvar biopsy punch has a ribbed sturdy handle for maximum control and comfort. Box of 25.

● **2mm Tip**

REF 1322 \$52⁹⁵

● **3mm Tip**

REF 1323 \$52⁹⁵

● **4mm Tip**

REF 1324 \$52⁹⁵

● **5mm Tip**

REF 1325 \$52⁹⁵

● **6mm Tip**

REF 1326 \$52⁹⁵



Keyes Vulvar Punch Set

This essential Keyes Vulvar Punch set includes a sturdy universal handle with six high quality stainless steel interchangeable screw tips, ranging from 2mm to 7mm in diameter. The set comes in a storage case with numerically designated holding pins for each tip to stabilize tip while attaching handle. **Tip Sizes:** 2mm - 7mm

REF 1310 Set..... \$229⁹⁵



Keyes Punch Accessories Kit

The perfect accessory kit for your Keyes Punch set. This kit includes a small forceps for lifting the tissue sample and a pair of scissors for snipping it off. The diamond-coated sharpening stone will keep your Keyes punches like new.

Each Kit Contains:

- Small Pick-Up Forceps
- Small Scissors
- Diamond Coated Sharpening Stone

REF KPA1315 \$99⁹⁵



Patel™ Multi-Use Forceps

New

The one instrument that every gynecologist needs in their practice. With its patent-pending design, the Patel™ excels at multiple functions!

REF NHL3450 \$119⁹⁵

Atraumatic, Waffle Pattern
Jaw Provides Greater Grip

Off-Centered Tip Provides Better
Visualization During Procedures

Ratchet Handle

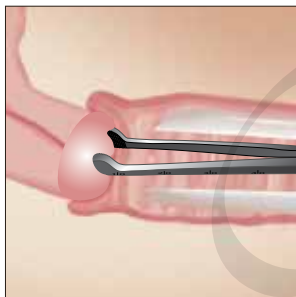

Atraumatic Tissue Grasper

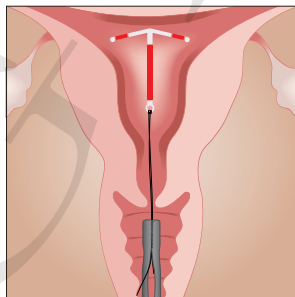

IUD Remover

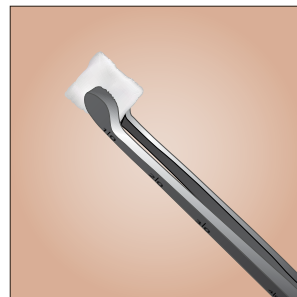

Sponge Forceps

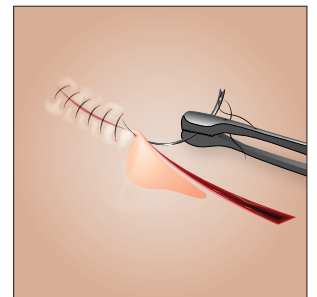

Needle Holder

ONYX IUD String Scissors

Blunt Tip, Slight Curve, Fine Serration

Onyx Titanium Coated Stainless Steel

KEY ADVANTAGES

- Incomparable cutting-edge hardness
- Extremely rust and corrosion resistant
- Smoother mechanical action
- Low friction coefficient

Length: 25cm

REF 29-040 \$114⁹⁵

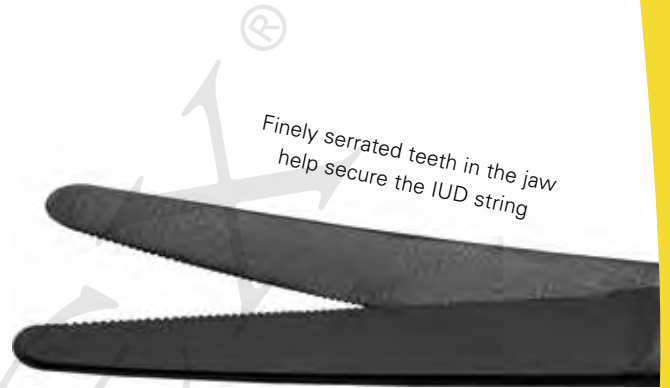

Our popular IUD String Scissors are now more durable and sharper than ever!



IUD String Scissors

Blunt Tip, Slight Curve, Fine Serration

High Quality Stainless Steel

Length: 25cm

REF 29-030 \$85⁹⁵



VILLA™

New

Hormonal Implant Dissecting Forceps

The Villa™ Hormonal Implant Dissecting Forceps and Implant Remover make the perfect pair in the event that an implant is not visible upon incision. After making an incision, some implants remain difficult or impossible to view. If this is the case, the dissecting forceps, with pointed tip, can be opened and closed to separate the tissue encapsulating the implant. This will allow the remover to grasp, hold, and retract the implant.

Villa™ Hormonal Implant Dissecting Forceps

REF 29-700 \$54⁹⁵

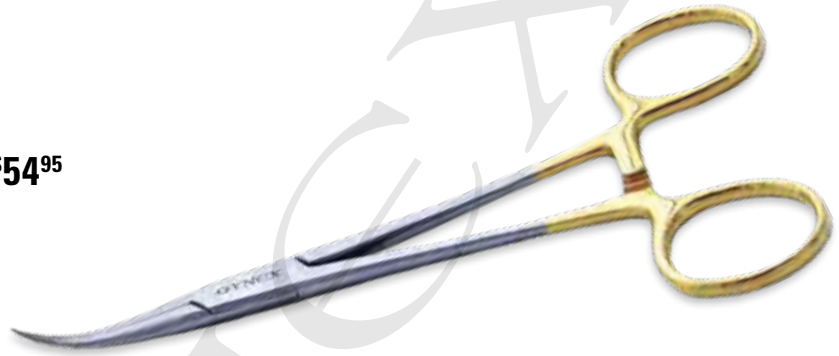

*Designed to aid with dissection
of a contraceptive implant
prior to removal.*



VILLA™

New

Hormonal Implant Remover

The Villa™ Hormonal Implant Remover is a clamp specially designed to grasp, hold, and retract a contraceptive implant located in the arm, such as Nexplanon®. A small, ring tip secures around the mid-point of the implant for modified "U" technique.

Villa™ Hormonal Implant Remover, Straight

REF 29-800 \$56⁹⁵

Villa™ Hormonal Implant Remover, Angled

REF 29-900 \$56⁹⁵

Villa™ Hormonal Implant Remover, Set

Includes: 1 Straight, 1 Angled

REF 29-850 \$96⁹⁵



Designed to grasp, hold, and retract a contraceptive implant located in the arm, such as Nexplanon®, using a modified "U" technique.

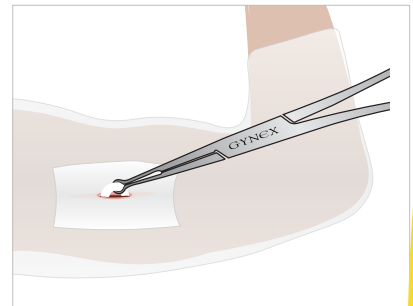
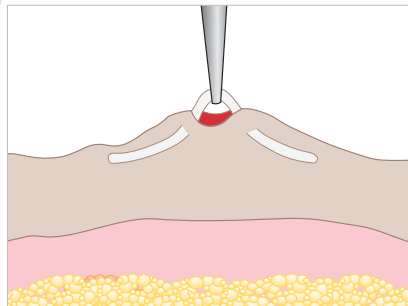
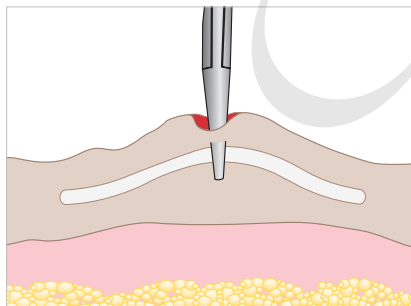

IUD String Scissors, Single-Use

STERILE EO Single-Use

Not made with natural rubber latex.

Metal Tip / Plastic Handle

- Handle features guide to reduce splaying

Length: 26.5cm

REF 29-065 Box of 12 \$49⁹⁵



Gynex® Alligator Grasper

Blunt tip, Fine Serrated Teeth

High Quality Stainless Steel

Perfect for grasping IUD strings

Length: 23cm

Finely serrated teeth in the jaw secures the IUD string

GYNEX®
Original!

Available in Two Jaw Size

REF 29-100 Jaw Size: 20mm \$97⁹⁵

REF 29-550 Jaw Size: 10mm \$97⁹⁵



Serpentine Grasper IUD Remover

Flexible Shaft, Small Tip, Grasping Teeth

High Quality Stainless Steel

KEY ADVANTAGES

- Flexible shaft offers over 360° of mobility
- Shaft holds desired position until reshaped
- Small tip provides easy access

Length: 20cm

Tip in closed position: 4.5mm

REF 29-010 \$319⁹⁵



IUD Remover, Crochet Style, Single-Use

STERILE EO **Single-Use**

Not made with natural rubber latex.

Rounded Tip, Angled, Dual Grasping Slots

Length: 26.5cm

REF 29-200 Box of 12 **\$59⁹⁵**



Willows™ IUD String Snare, Single-Use

STERILE EO **Single-Use**

Not made with natural rubber latex.

Rounded Tip, Multiple Grasping Slots

- High quality malleable plastic

Length: 27cm

REF 29-300 Box of 12 **\$59⁹⁵**

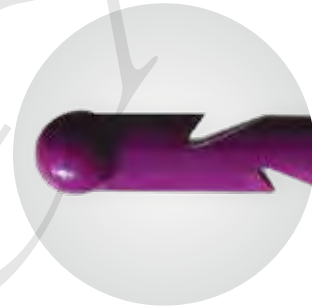

IUD Remover, Crochet Style

Rounded Tip, Angled, Dual Grasping Slots

Length: 26cm

REF 29-020 **\$82⁹⁵**

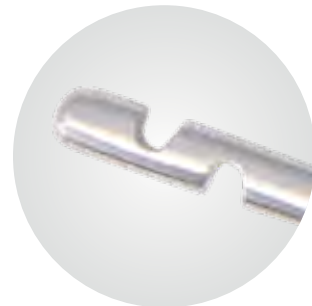

Malleable IUD Remover, Crochet Style

Rounded Tip, Angled, Dual Grasping Slots

High Quality Malleable Metal

Length: 26cm

REF 29-025 **\$92⁹⁵**



ASCONA™ IUD String Snare

Effortless IUD Removal with Precision and Security

The ASCONA™ IUD String Snare is expertly designed to ensure secure and efficient IUD removal. Simply twist the hook to and advance the coiled outer shaft to secure the string for removal. The ASCONA™ can be disassembled for thorough cleaning and sterilization. The flexible shaft and detachable hook make maintenance hassle-free.

REF 29-350 \$87⁹⁵

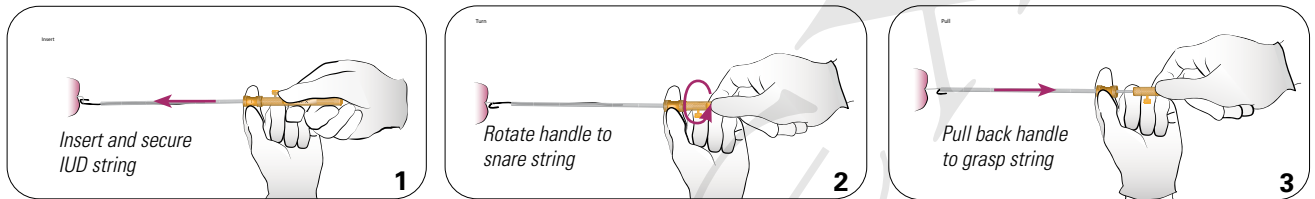

Gynex® IUD Insertion Kit, Single-Use

STERILE EO Single-Use

Not made with natural rubber latex.

- Reduces the risk of transmission of infectious agents
- Eliminates costly instrument sterilization

**GYNEX®
Original!**

REF 29-500 Box of 12..... \$194⁹⁵

EACH KIT TRAY CONTAINS:

- (1) Tenaculum Forceps
- (1) IUD String Scissor
- (2) Rayon Swabs
- (1) ACCU-SOUND® Uterine Sound
- (1) Folded Drape



Uterine Sounds

ACCU-SOUND® Uterine Sound, Single-Use

STERILE EO Single-Use

Not made with natural rubber latex.

The simple yet ingenious design of the ACCU-SOUND® Uterine Sound eliminates the guesswork involved with a standard uterine sound. When inserting the ACCU-SOUND® into the uterus, the ring rests against the outside of the Os. When the device is withdrawn from the uterus and vagina, the ring stays in place, clearly indicating the uterine measurement.

Length: 24cm

Shaft Diameter: 3mm

REF 4950 Box of 25 \$74⁹⁵



Not Shown at Actual Size

1

Gently insert ACCU-SOUND® uterine sound's dilating tip into the cervical Os.



2

Gently advance the ACCU-SOUND® Uterine Sound until the back of the uterus is felt.

ACCU-SOUND® Uterine Sound ring will rest against the outside of the cervical Os.



3

Withdraw ACCU-SOUND® Uterine Sound from the uterus and vagina. The ring will remain in place on the uterine sound indicating the uterus measurement.

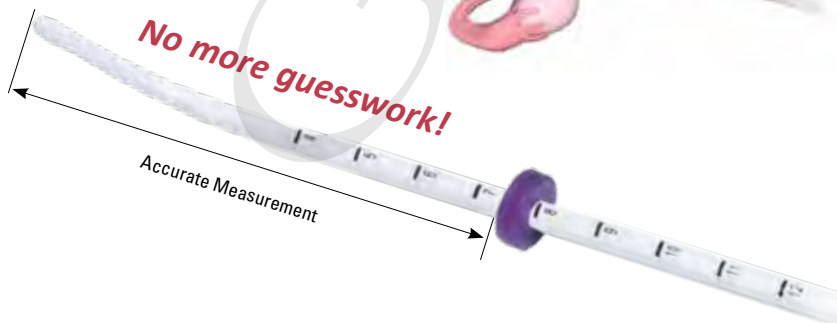

An accurate measurement is indicated by the location of the ring on the ACCU-SOUND® Uterine Sound

Sims Sound • flex, Single-Use

STERILE EO Single-Use

Not made with natural rubber latex.

GYNEX®
Original!

New

Gynex has improved the Sims Sound. Engineered from specifically formulated memory polymer, the Sims Sound Flex formable shaft enhances the providers ability to pre-shape the sound to meet each patient's unique physical requirements. Bold, laser-etched markings along the shaft provide clear, reliable measurements.

- Formable Memory Polymer
- OD 4mm

Working Length: 16.6cm

REF 4630 Box of 25 \$57⁹⁵



Not Shown at Actual Size

Sims Sound Plus+, Single-Use

STERILE EO Single-Use

Not made with natural rubber latex.

- Malleable plastic
- OD 4mm

Length: 24cm

REF 4675 Box of 25 \$59⁹⁵



Not Shown at Actual Size

Sims Sound, Single-Use

STERILE EO Single-Use

Not made with natural rubber latex.

- Malleable plastic
- OD 4mm

Length: 16.6cm

REF 4601 Box of 25 \$57⁹⁵



Not Shown at Actual Size

Sims Sound, REUSABLE

- Autoclavable
- OD 4mm

Length: 32cm

REF 4334 Stainless Steel, Non-Malleable \$47⁹⁵

REF 4336 Stainless Steel, Malleable \$52⁹⁵



Not Shown at Actual Size

Uterine Dilators

Mini Dilator Set

Set of 5 inter-changeable Probes and 1 Handle

High Quality Stainless Steel

Sizes: 1mm, 1.5mm, 2mm, 2.5mm and 3mm

REF 4005 Set.....\$182⁹⁵

Dots show actual diameter in mm



Especially useful for nulliparous patients

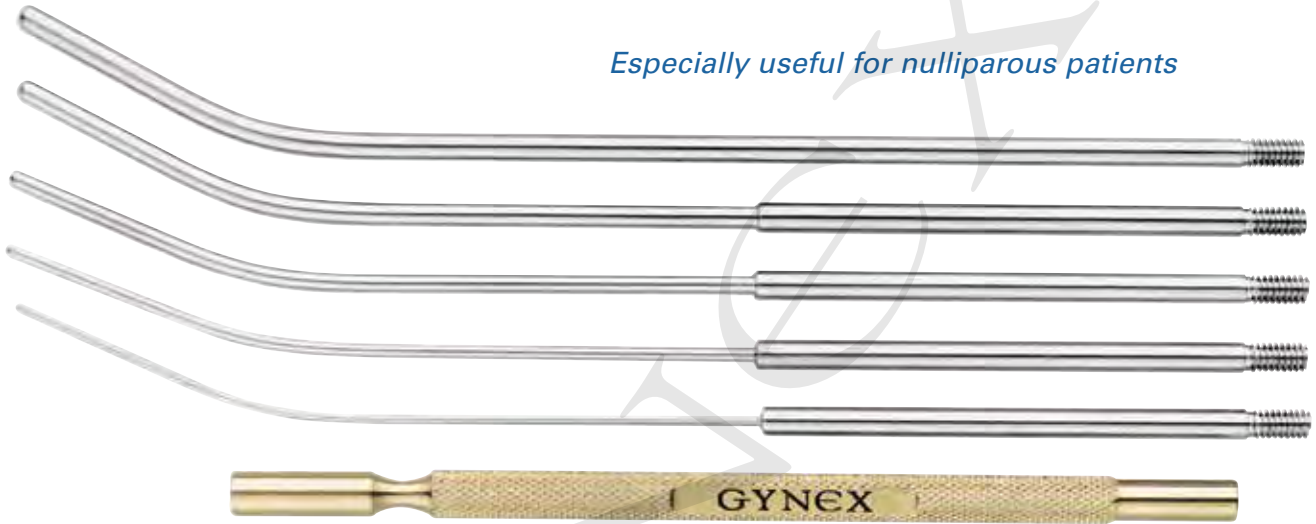

Extra Mini Dilator Tips

(Fits REF 4005 Handle)

Sizes: 1.5mm, 2.5mm, 4mm and 5mm

Available only from GYNEX

REF 4005.1.5	1.5mm	\$47 ⁹⁵
REF 4005.2.5	2.5mm.....	\$47 ⁹⁵
REF 4005.4	4mm.....	\$47 ⁹⁵
REF 4005.5	5mm.....	\$47 ⁹⁵



Dots show actual diameter in mm



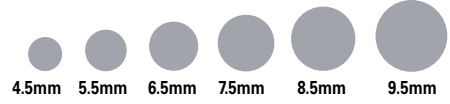

Dots show actual diameter in mm

Small Dilator Set of 6 Probes

- Each probe is one size
- Stainless Steel

Length: 19.2cm

REF 4008 Set **\$179⁹⁵**

Sold individually **\$45⁹⁵**

Hank Dilator Set of 6 Probes

- Dual size on each dilator
- Stainless Steel

Length: 26.9cm

REF 4010 Set..... **\$187⁹⁵**

Sold individually **\$46⁹⁵**

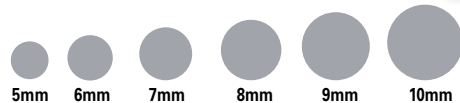

Hegar Dilator Set of 8 Dilators

- Dual sizes on each dilator
- Stainless Steel

Length: 21cm

REF DHU3800 Set **\$197⁹⁵**



Dots show actual diameter in mm

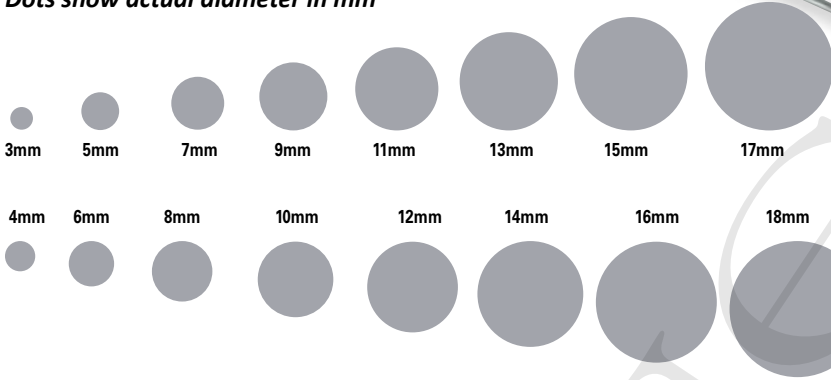

**Product not shown at actual size*

Pratt Dilator Set of 8 Dilators

- Dual sizes on each dilator
- Stainless Steel

Length: 29.5 cm

REF DPU3850 Set **\$199⁹⁵**

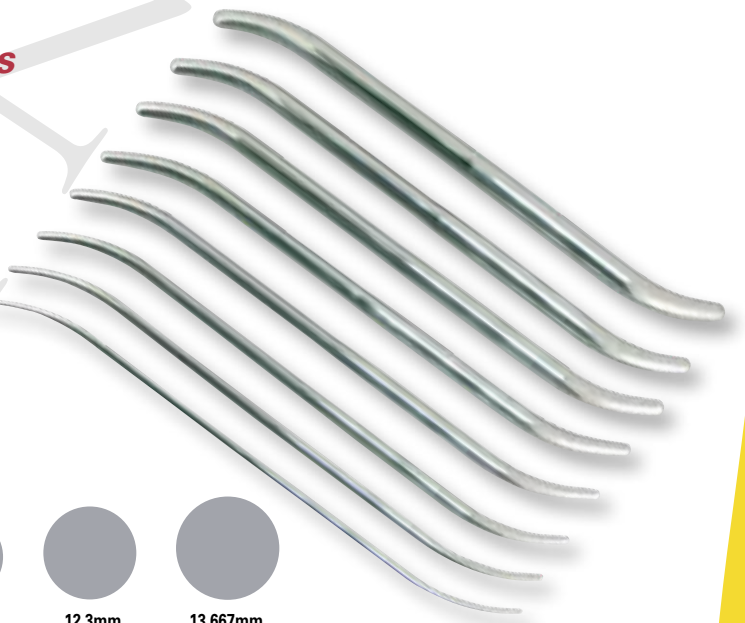

Dots show actual diameter in mm

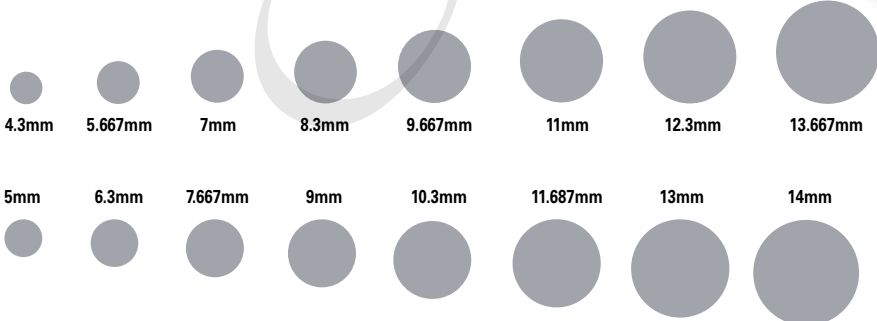

**Product not shown at actual size*

Soft Dilators, Single-Use

STERILE EO **Single-Use**
 Not made with natural rubber latex.

Designed to dilate the cervical canal to allow entry into the uterus for evaluation of the cervical canal or uterine cavity. These color coded dilators are soft and malleable allowing the operating physician to dilate with excellent control.

Soft Dilator, Os Locator

Used for locating the external Os by gently pushing the tip against the cervix.

Tapered Tip Length: 23mm

Overall Length: 21.5cm

- REF 4211 Box of 12 \$57⁹⁵
- REF 4221 Box of 24 \$104⁹⁵

Soft Dilator, Canal Finder

Used for indicating the cervical canal.

Tapered Tip Length: 45mm

Overall Length: 21.5cm

- REF 4212 Box of 12 \$57⁹⁵
- REF 4222 Box of 24 \$104⁹⁵

Soft Dilator, Fundus Finder

Used for establishing the entire length of the cervical canal from external Os to the internal Os.

Tapered Tip Length: 85mm

Overall Length: 21.5cm

- REF 4213 Box of 12 \$57⁹⁵
- REF 4223 Box of 24 \$104⁹⁵

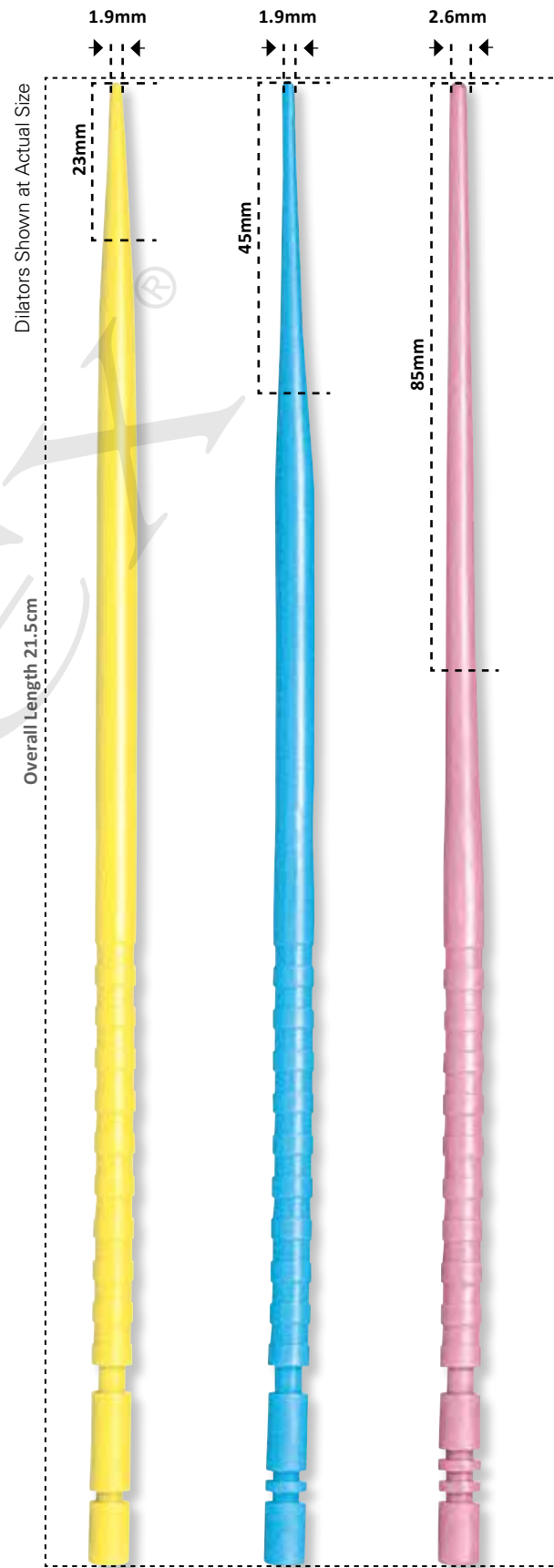

Os Locator Single-Use **Canal Finder** Single-Use **Fundus Finder** Single-Use

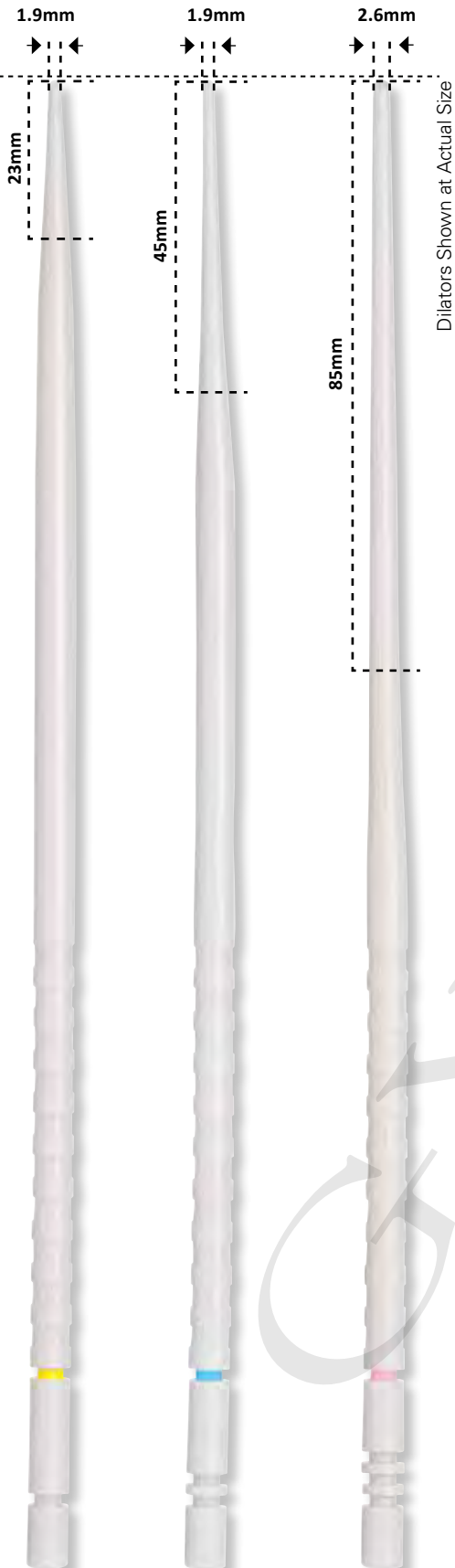

Os Locator
Reusable

Canal Finder
Reusable

Fundus Finder
Reusable

Soft Teflon Dilators, REUSABLE

Designed to dilate the cervical canal to allow entry into the uterus for evaluation of the cervical canal or uterine cavity. These Soft Teflon Dilators are reusable, fully autoclavable and can be sterilized after use. Each of these three dilators are comfortable to hold and allow the operating physician to dilate with excellent control.

Soft Teflon Dilator, **Os Locator**

Tapered Tip Length: 23mm

Overall Length: 21.5cm

REF 4201

\$49⁹⁵

Soft Teflon Dilator, **Canal Finder**

Tapered Tip Length: 45mm

Overall Length: 21.5cm

REF 4202

\$49⁹⁵

Soft Teflon Dilator, **Fundus Finder**

Tapered Tip Length: 45mm

Overall Length: 21.5cm

REF 4203

\$49⁹⁵

STERILE / Reusable
OK to Autoclave



Great Value!

SAVE on a SET of 3 Dilators

STERILE / Reusable
OK to Autoclave

Soft Teflon Dilators Set, REUSABLE

Set of three includes: one Os Locator, one Canal Finder and one Fundus Finder.

REF 4200

Set of 3 \$99⁹⁵

Note: Multi-Colored Single-Use [®] and the White Reusable Soft Dilators are the same shape and are intended for identical use.

5% Discount on Prepaid Orders by Check or ACH payment (offer excludes microscopes, colposcopes and/or extended warranties).

Dennis Dilators[®], Single-Use

STERILE EO Single-Use[®]

Not made with natural rubber latex.

5mm to 12mm

- Dual sizes on each dilator
- Diameter marked on handle for easy identification
- Ergonomic handle

Overall Length: 27cm

5-6mm Dilator

REF 4240 Box of 12 **\$64⁹⁵**

7-8mm Dilator

REF 4245 Box of 12 **\$64⁹⁵**

9-10mm Dilator

REF 4250 Box of 12 **\$64⁹⁵**

11-12mm Dilator

REF 4255 Box of 12 **\$64⁹⁵**

Procedure Blister Tray

- Safe and Secure
- Sterile
- Easy Open Cover



Dots show actual diameter in mm

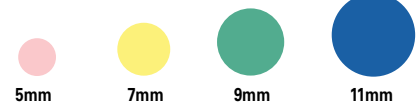

Dennis Dilators® Set, REUSABLE

STERILE EO

Not made with natural rubber latex.

5mm to 14mm

- Dual sizes on each dilator
- Diameter marked on handle for easy identification

Overall length: 28cm

Great Value!

SAVE on a SET of 5 Dilators

REF 4230 Set of 5 \$99⁹⁵



STERILE / Reusable
OK to Autoclave

Procedure Blister Tray

- Safe and Secure
- Sterile
- Easy Open Cover



Dots show actual diameter in mm

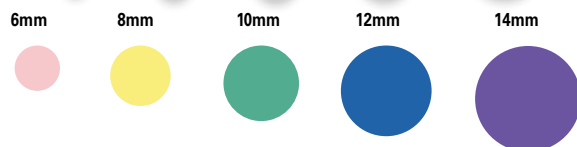
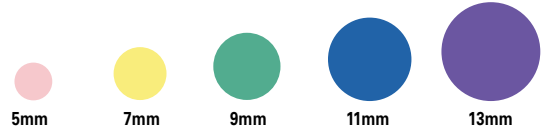

Uterine Curettes

Sims Uterine Curette

Sharp & Rigid

All Sims Uterine Curette Tips Shown at Actual Size



Size 00 **Size 0** **Size 1** **Size 2** **Size 3** **Size 4** **Size 5** **Size 6**

REF CSU3900-9
Size 00: 10.5 x 4.0mm, Sharp, Rigid..... **\$74⁹⁵**

REF CSU3900-0
Size 0: 10.5 x 4.5mm, Sharp, Rigid..... **\$74⁹⁵**

REF CSU3900-1
Size 1: 13 x 5mm, Sharp, Rigid..... **\$74⁹⁵**

REF CSU3900-2
Size 2: 16 x 6mm, Sharp, Rigid..... **\$74⁹⁵**

REF CSU3900-3
Size 3: 16 x 7mm, Sharp, Rigid..... **\$74⁹⁵**

REF CSU3900-4
Size 4: 20 x 9mm, Sharp, Rigid..... **\$74⁹⁵**

REF CSU3900-5
Size 5: 22 x 9mm, Sharp, Rigid..... **\$74⁹⁵**

REF CSU3900-6
Size 6: 26 x 11mm, Sharp, Rigid..... **\$74⁹⁵**



Bumm Uterine Curette

Sharp & Rigid

All Bumm Uterine Curette Tips Shown at Actual Size



Size 1 **Size 2** **Size 3**

REF CBU3920-1
Size 1: 48 x 25mm **\$72⁹⁵**

REF CBU3920-2
Size 2: 52 x 30mm **\$72⁹⁵**

REF CBU3920-3
Size 3: 62 x 35mm **\$72⁹⁵**

Century UMI™

Uterine Manipulator/Injector

STERILE EO Single-Use

Not made with natural rubber latex.

The Century UMI™ Uterine Manipulator is easy-to-use and designed for patient safety. Optimized to support a broad procedural versatility: Laparoscopic Tubal Occlusion, Diagnostic Laparoscopy, Minilaparotomy, Salpingoplasty and Fertility Exams.

Cannula Length: 33cm

OD: 4.5mm

Features

- Pear-shaped balloon for optimal hold
- Incorporated cervical stop (no spring!)
- Cannula to allow easy insertion
- Balloon forms an excellent seal at internal Os

Now including a 10cc luer lock syringe for your convenience!

LOW PRICE!

Low unit price, **\$19.16** each

REF 10-160 Box of 12 **\$229⁹⁵**

Passing Savings To You!

Note: It is highly recommended that the practitioner utilize a sound to determine the patient's uterine depth prior to using any uterine manipulator/injector.

sure@sample® • *Select 1*

Endometrial Curette

STERILE EO Single-Use 
 Not made with natural rubber latex.

Suresample® *Select 1* is a uniquely designed curette for sampling the uterine endometrium, ideal for obtaining samples from the uterus and mucosal lining by scraping or vacuum suction.

Cannula Length: 8-1/8" (20.5cm)

OD: 3mm

Features

- Randall-Style sharp cutting-edge
- Semi flexible curette with slight curve
- Easily readable 1cm markings on cannula
- White Cannula Stylet insert for additional rigidity
- Depth Marker acts as a visual aid to protect against perforation
- 10mL standard syringe with Twist-and-Lock plunger

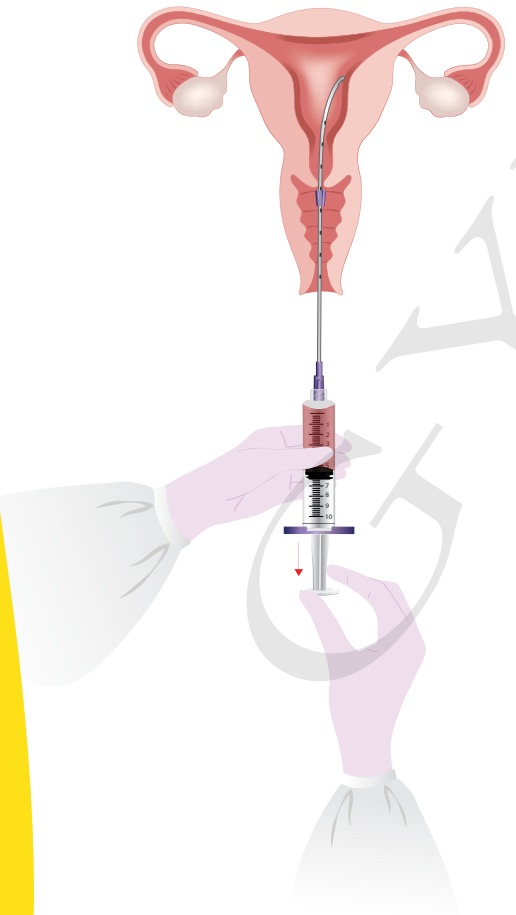

REF 3130	Box of 5.....	\$36⁹⁵
REF 3135	Box of 24.....	\$144⁹⁵

The unique design and special features allow for better accuracy and a more reliable sample.

sure@sample® • Select 1

Endometrial Curette

Simple, Safe and Effective

Tapered tip for easier insertion.
Randall - Style sharp cutting edge.

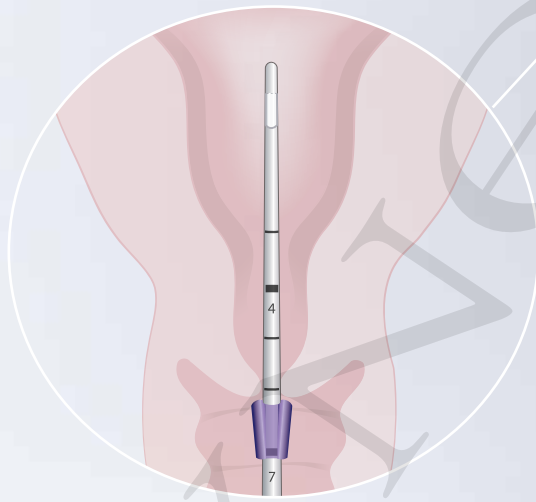

DEPTH MARKER

Set the desired curette marker depth after sounding the uterus.
This depth marker acts as a visual aid to reduce the risk of perforation.

TWIST AND LOCK PLUNGER

The twist-and-lock plunger on the syringe allows the provider to maintain a constant vacuum pressure while collecting the specimen



The endometrial sampler with a proven track record!

sure@sample® Endometrial Sampler

The Suresample® Endometrial Sampler has been trusted by doctors for over **25 years**

Our **patented 3-port sampling system** doubles the harvested samples of tested competitors and allows **easy retrieval** with **reduced cell damage**. A much **greater histological adequacy and integrity** than any other samplers. 12 to 1 ratio of histological adequacy and 8 to 3 for histological integrity, Suresample® is the finest endometrial sampler.

Suresample® formable shaft memory allows the physicians to **pre-shape shaft** to meet each patient's unique physical requirements. Its tensile strength and rigidity make it malleable enough to conform to the direction of the cervix and lower segment, strong enough to access a tight canal. The formable 3mm shaft diameter enhances ease of use and minimizes patient discomfort.



AMOUNT OF BIOPSY TISSUE

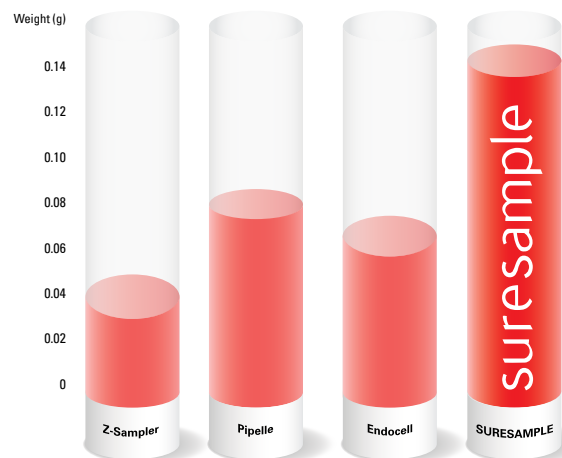

Better performance than other brands

Suresample® Endometrial Sampler retrieves more than twice the harvest of its competition!

sure@sample[®]

Endometrial Sampler

STERILE EO Single-Use 
 Not made with natural rubber latex.

Features and Benefits

- **3-Port Sampling System** - one port on each side of the distal end of the shaft and one on the tip end.
- **Grip retraction** creates a strong internal vacuum.
- **Two phase action** between the ports and grip produce a higher yield of tissue sample in an amazingly controlled manner.
- **Formable memory shaft** allows physician to shape the sampler to meet each patient's physical requirements.
- **Tensile strength and rigidity** allow conformity but also provide enough strength to access through a smaller canal.
- **No cutting or splitting of tip** (a tedious process required by other widely used samplers that leads to damaged specimen).
- **Quick retrieval process** - simply push the SURESAMPLE[®] Endometrial Sampler grip back, forcing the specimen out of the open sampler tip and sides.

Shaft Diameter: 3mm
Shaft Length: 24cm

REF 3115 Box of 25..... \$129⁹⁵



Formable Shaft



Extended Piston

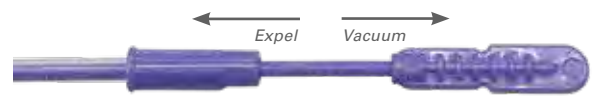

Outer Shaft Control Cuff

Grip

Galileo® Colposcope Direct-Access™ 530VCDA

Three-Step Magnification with Integrated LED Light and HD Video Camera

Designed with a patented offset center post for direct access, The Galileo Colposcope is a work of art in both form and function.

Features

- Direct-Access™ Offset Center Post
(Allows for unobstructed access to the examination site)
- Multi-Coated, Hand-Polished Apochromatic German Lens
(Minimizes secondary color and corrects chromatic aberration)
- Integrated Power Source and Cables
(Enclosed for a clean and clutter free look)
- Low voltage DC power
(Eliminates the need to replace fuses)
- LED Illumination System
(Accurate color balance, cool to the touch, long bulb life)
- Three-Step Magnification
- Observation Site Measurement Rings
- Individual Eye-Shields
- Integrated Green Filter
- HDMI Video
(Allows for live feed and image/video capture)

Options

- 360° Tilt Stand Base / 5-Wheel Rolling Stand Base
- Additional Extended Warranty

Specifications

- Focal Length: ± 300mm
- Magnification: 3.75X, 7.5X, 15X
- Field Of View: 79mm, 39mm, 19mm
- Depth Of Field: 4.5mm, 1.13mm, 0.76mm
- Light Intensity: > 30,000 LUX
- Working Height: 975mm to 1135mm
- Power Supply: 100V to 240V
- Video Feed: HDMI-Video
- Warranty: 1 Year - Parts and Labor (excludes shipping charges)



with a 5-wheel Rolling Base

REF 530VCDA-R \$7,995⁰⁰

1 Year Extended Warranty

REF 530VCDA-T/R-1 \$575⁰⁰

with a 360° rotating Tilt Base

REF 530VCDA-T \$7,995⁰⁰

2 Year Extended Warranty

REF 530VCDA-T/R-2 \$825⁰⁰

Galileo Design Team is the Proud Recipient of the German • Red Dot Concept Design Award

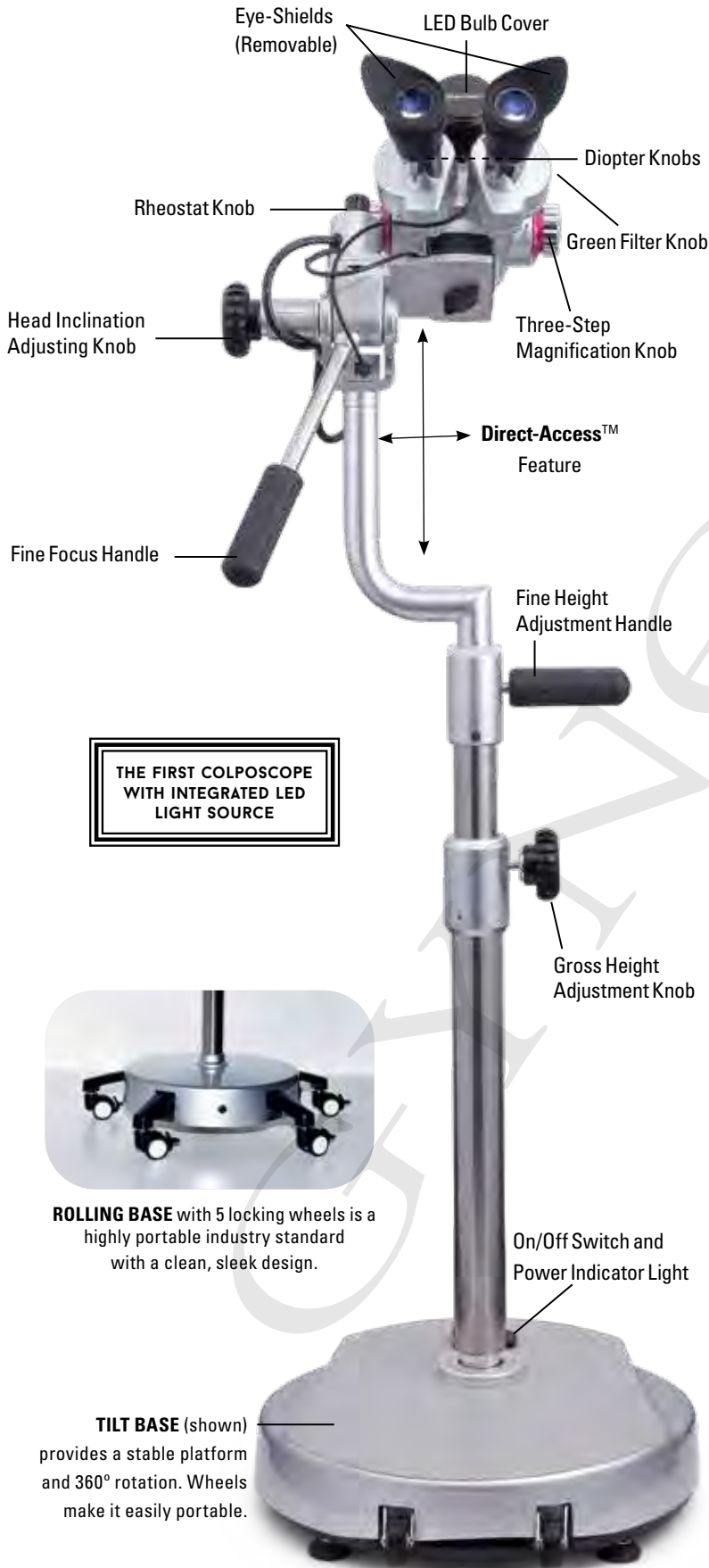

Our colposcopes now utilize low-voltage DC power eliminating the need to replace fuses!



360° Tilt Base
Easy Maneuverability



Superb German Optics
Apochromatic Lens
High Resolution
Large Depth of Field
Wide Field of View
Great Contrast
3-D Image Reproduction



LED Light Source
Lasts Longer
Cool To The Touch
Optimal Color Balance



ROLLING BASE with 5 locking wheels is a highly portable industry standard with a clean, sleek design.

TILT BASE (shown) provides a stable platform and 360° rotation. Wheels make it easily portable.



Galileo® Colposcope Direct-Access™ 400DA

Three-Step Magnification with Integrated LED Light

Designed with a patented offset center post for direct access, The Galileo Colposcope is a work of art in both form and function.

Features

- Direct-Access™ Offset Center Post
(Allows for unobstructed access to the examination site)
- Multi-Coated, Hand-Polished Apochromatic German Lens
(Minimizes secondary color and corrects chromatic aberration)
- Integrated Power Source and Cables
(Enclosed for a clean and clutter free look)
- Low voltage DC power
(Eliminates the need to replace fuses)
- LED Illumination System
(Accurate color balance, cool to the touch, long bulb life)
- Three-Step Magnification
- Observation Site Measurement Rings
- Individual Eye-Shields
- Integrated Green Filter

Options

- 360° Tilt Stand Base / 5-Wheel Rolling Stand Base
- Additional Extended Warranty

Specifications

- Focal Length: ± 300mm
- Magnification: 3.75X, 7.5X, 15X
- Field Of View: 79mm, 39mm, 19mm
- Depth Of Field: 4.5mm, 1.13mm, 0.76mm
- Light Intensity: > 30,000 LUX
- Working Height: 975mm to 1135mm
- Power Supply: 100V to 240V
- Warranty: 1 Year - Parts and Labor (excludes shipping charges)



with a 5-wheel Rolling Base

REF 400DA-R \$6,295⁰⁰

1 Year Extended Warranty

REF 400DA-T/R-1 \$450⁰⁰

with a 360° rotating Tilt Base

REF 400DA-T \$6,295⁰⁰

2 Year Extended Warranty

REF 400DA-T/R-2 \$645⁰⁰

Galileo Design Team is the Proud Recipient of the German • Red Dot Concept Design Award

Our colposcopes now utilize low-voltage DC power eliminating the need to replace fuses!



360° Tilt Base
Easy Maneuverability



Superb German Optics
Apochromatic Lens
High Resolution
Large Depth of Field
Wide Field of View
Great Contrast
3-D Image Reproduction



LED Light Source
Lasts Longer
Cool To The Touch
Optimal Color Balance

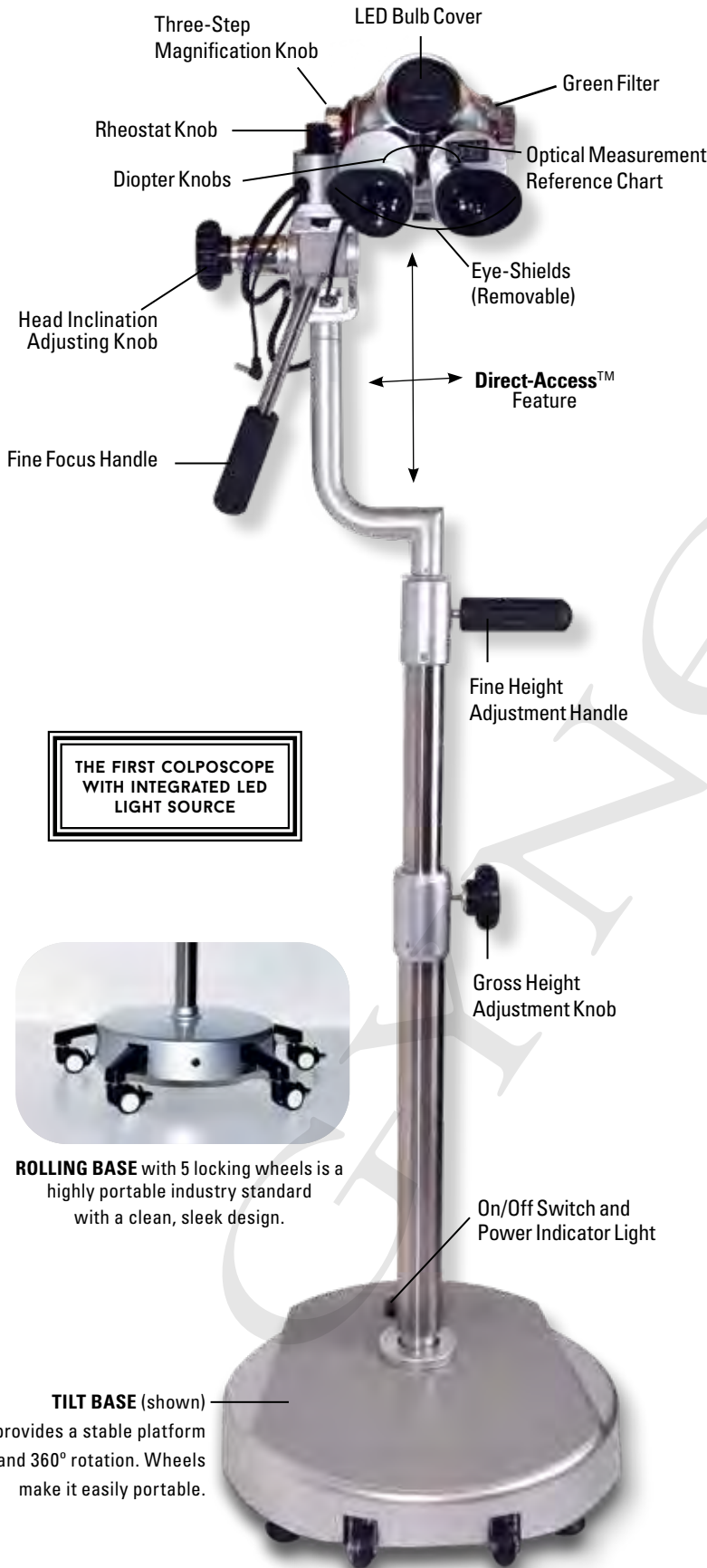

THE FIRST COLPSCOPE WITH INTEGRATED LED LIGHT SOURCE



ROLLING BASE with 5 locking wheels is a highly portable industry standard with a clean, sleek design.

TILT BASE (shown) provides a stable platform and 360° rotation. Wheels make it easily portable.

Galileo® Colposcope Direct-Access™ 200DA

Single Magnification with Integrated LED Light

Designed with a patented offset center post for direct access, The Galileo Colposcope is a work of art in both form and function.

Features

- Direct-Access™ Offset Center Post
(Allows for unobstructed access to the examination site)
- Multi-Coated, Hand-Polished Apochromatic German Lens
(Minimizes secondary color and corrects chromatic aberration)
- Integrated Power Source and Cables
(Enclosed for a clean and clutter free look)
- Low voltage DC power
(Eliminates the need to replace fuses)
- LED Illumination System
(Accurate color balance, cool to the touch, long bulb life)
- Single Magnification
- Observation Site Measurement Rings
- Individual Eye-Shields
- Integrated Green Filter

Options

- 360° Tilt Stand Base / 5-Wheel Rolling Stand Base
- Additional Extended Warranty

Specifications

- Focal Length: ± 300mm
- Magnification: 7.5X
- Field Of View: 39mm
- Depth Of Field: 1.13mm
- Light Intensity: > 30,000 LUX
- Working Height: 975mm to 1135mm
- Power Supply: 100V to 240V
- Warranty: 1 Year - Parts and Labor (excludes shipping charges)



with a 5-wheel Rolling Base

REF 200DA-R \$4,995⁰⁰

1 Year Extended Warranty

REF 200DA-T/R-1 \$375⁰⁰

with a 360° rotating Tilt Base

REF 200DA-T \$4,995⁰⁰

2 Year Extended Warranty

REF 200DA-T/R-2 \$535⁰⁰

Galileo Design Team is the Proud Recipient of the German • Red Dot Concept Design Award

Our colposcopes now utilize low-voltage DC power eliminating the need to replace fuses!



360° Tilt Base

Easy Maneuverability



Superb German Optics

Apochromatic Lens

High Resolution

Large Depth of Field

Wide Field of View

Great Contrast

3-D Image Reproduction



LED Light Source

Lasts Longer

Cool To The Touch

Optimal Color Balance



LED Bulb Cover
Diopter Knobs
Rheostat Knob
Green Filter
Optical Measurement Reference Chart
Eye-Shields (Removable)

Head Inclusion Adjusting Knob

Fine Focus Handle

Direct-Access™ Feature

Fine Height Adjustment Handle

Gross Height Adjustment Knob

THE FIRST COLPSCOPE WITH INTEGRATED LED LIGHT SOURCE



ROLLING BASE with 5 locking wheels is a highly portable industry standard with a clean, sleek design.

On/Off Switch and Power Indicator Light

TILT BASE (shown) provides a stable platform and 360° rotation. Wheels make it easily portable.

Accessories

for Galileo® Colposcope Direct-Access™ 530VCDA

Video Capture Device

Connects Galileo® Colposcope 530VCDA to a PC for viewing and capturing images. Uses a USB 2.0 or 3.0 port on a computer.

REF VG-Magewell **\$314⁹⁵**



Cut the Cord!

Equipped with rechargeable battery.

Gynex® Monitor

The Gynex® monitor is equipped with a built-in rechargeable battery for your convenience. It offers a convenient viewing option for patients and staff with one single cable connecting colposcope to the monitor.

Monitor with Rolling Base

REF 450MS **\$2,695⁰⁰**

Monitor Only

REF 450M **\$324⁹⁵**

(Note: Actual monitor shipped may be different than model shown)

Galileo® Biological Microscope

Specifications

- **Condenser Numerical Aperture:** Na = 1.25
- **Stage Movement Range:** Longitudinal 50mm, Transverse 75mm
- **Fine Focusing:** Minimum Division .002mm
- **Interpupillary Distance Adjustment Range:** 53–75mm
- **Light Source:** 6v / 20w Halogen Lamp, Adjustable Brightness

Extended Warranties Available (Excludes shipping charges)

**Clearer images
and
wider views
at a great price!**

Eyepieces	10X Magnification	25mm Focus	Φ 18mm Field		
Objectives	Semi-Plan Achromatic				
	Magnification	4X	10X	40X	100X (oil)
	Total Magnification	40X	100X	400X	1000X
	N.A. (Numerical Aperture)	.1	.25	.65	1.25
	W.D. (mm)	23.1	4.1	.6	.38



Components

- Plastic Carrying Case
- 2 Eyepieces
- 1 Extra Fuse
- 1 Extra Bulb
- 1 Dust Cover
- 1 Instructions for Use
- 1 Bottle of Immersion Oil

Warranty: 1 Year - Parts and Labor

Galileo Biological Microscope

REF MI-6000 \$995⁹⁵

1 Year Extended Warranty

REF MI-6000-1 \$115⁰⁰

2 Year Extended Warranty

REF MI-6000-2 \$175⁰⁰

CO4100 Colposcope

Three-Step Magnification, 45° Angle with Integrated LED Light

The CO4100 Colposcope features three-step magnification and 45° viewing angle with integrated LED light. The 45° angle lenses allow inclined viewing for a natural sitting position, reducing the need to bend over. The CO4100 Colposcope includes excellent optics designed to facilitate comprehensive cervical examination, with ease and style.

Features

- Multi-Coated, Hand-Polished Apochromatic Lens
(Minimizes secondary color and corrects chromatic aberration)
- Integrated Power Source and Cables
(Enclosed in base and post for a clean and clutter free look)
- Low voltage DC power
(Eliminates the need to replace fuses)
- LED Illumination System
(Accurate color balance, cool to the touch, long bulb life)
- Three-Step Magnification
- Optical Measurement Rings
- Individual Eye-Shields
- Integrated Green Filter
- Adjustable Tension Ball-Joint for Easy 360° Motion

Specifications

- Focal Length: ± 316mm
- Magnification: 3.75X, 7.5X, 15X
- Optical Angle: 45°
- Field Of View: 9.5mm, 19mm, 38mm
- Depth Of Field: 5mm, 8mm, 32mm
- Light Intensity: > 25,000LUX
- Working Height: 838mm to 1194mm (33" to 47")
- Power Supply: 90V to 240V
- Warranty: 1 Year - Parts and Labor (excludes shipping charges)

Options

- Additional Extended Warranty



with a 360° rotating Tilt Base

REF CO4100-LED **\$5,295⁰⁰**

1 Year Extended Warranty

REF CO4100-1 **\$450⁰⁰**

2 Year Extended Warranty

REF CO4100-2 **\$645⁰⁰**

These circles indicate the millimeter size at the tissue site.

ϕ mm	A	B
3.75X	3.5	17
7.5X	2	8.8
15X	0.9	4.4



Our colposcopes now utilize low-voltage DC power eliminating the need to replace fuses!



LED Light Source

- Lasts Longer
- Cool To The Touch
- Optimal Color Balance



Universal Teflon Ball Joint

- 360° Easy Maneuver

CO3100 Colposcope

Three-Step Magnification with Integrated LED Light

The CO3100 Colposcope features three-step magnification with integrated LED light. The device is compact, and light-weight with 360° tilt base for easy maneuverability. The CO3100 Colposcope includes excellent optics designed to facilitate comprehensive cervical examination, with ease and style.

Features

- Multi-Coated, Hand-Polished Apochromatic Lens
(Minimizes secondary color and corrects chromatic aberration)
- Integrated Power Source and Cables
(Enclosed in base and post for a clean and clutter free look)
- Low voltage DC power
(Eliminates the need to replace fuses)
- LED Illumination System
(Accurate color balance, cool to the touch, long bulb life)
- Three-Step Magnification
- Optical Measurement Rings
- Individual Eye-Shields
- Integrated Green Filter
- Adjustable Tension Ball-Joint for Easy 360° Motion

Specifications

- Focal Length: ± 316mm
- Magnification: 3.75X, 7.5X, 15X
- Field Of View: 9.5mm, 19mm, 38mm
- Depth Of Field: 5mm, 8mm, 34mm
- Light Intensity: > 25,000LUX
- Working Height: 838mm to 1194mm (33" to 47")
- Power Supply: 90V to 240V
- Warranty: 1 Year - Parts and Labor (excludes shipping charges)

Options

- Additional Extended Warranty



with a 360° rotating Tilt Base

REF CO3100-LED **\$4,695⁰⁰**

1 Year Extended Warranty

REF CO3100-1 **\$400⁰⁰**

2 Year Extended Warranty

REF CO3100-2 **\$550⁰⁰**

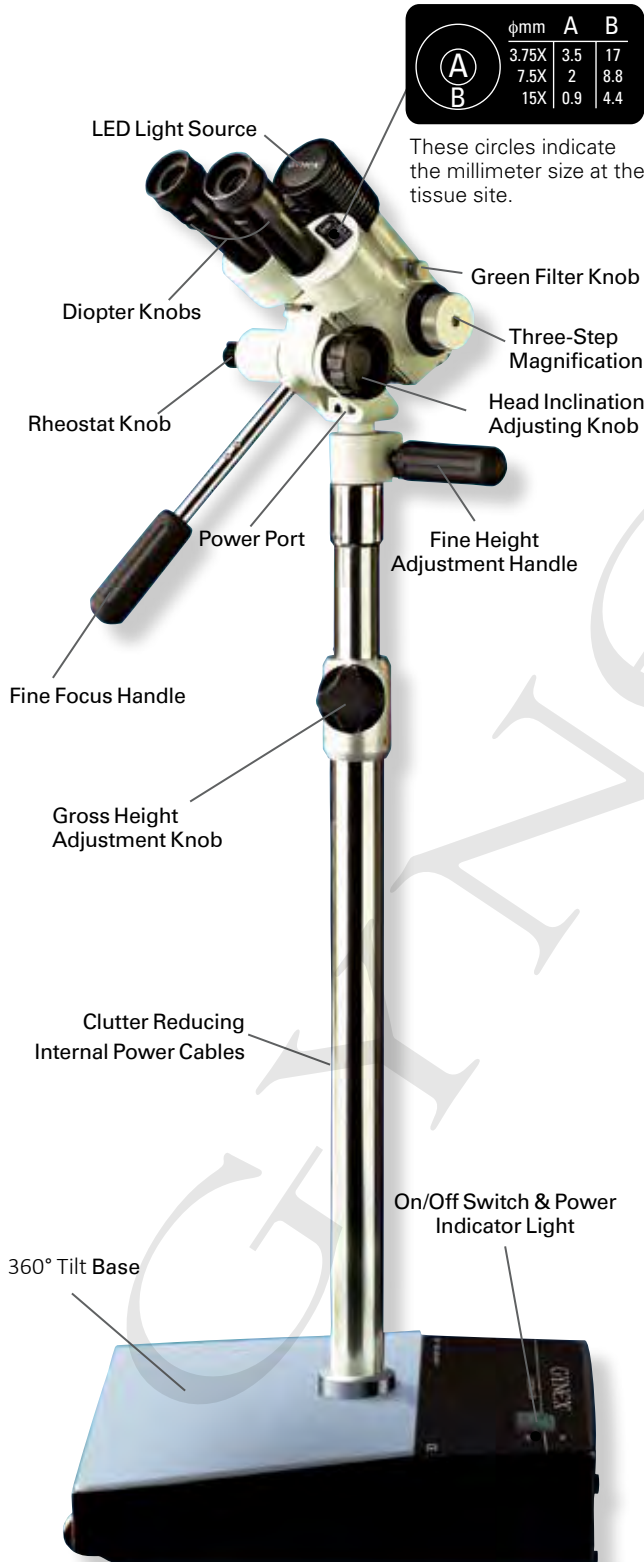

Our colposcopes now utilize low-voltage DC power eliminating the need to replace fuses!



LED Light Source

- Lasts Longer
- Cool To The Touch
- Optimal Color Balance



Universal Teflon Ball Joint

- 360° Easy Maneuver

CO1100 Colposcope

Single Magnification with Integrated LED Light

The CO1100 Colposcope features 9x magnification. The device is compact and light-weight with a with 360° tilt base for easy maneuverability. The CO1100 Colposcope includes excellent optics designed to facilitate comprehensive cervical examination, with ease and style.

Features

- Multi-Coated, Hand-Polished Apochromatic Lens
(Minimizes secondary color and corrects chromatic aberration)
- Integrated Power Source and Cables
(Enclosed in base and post for a clean and clutter free look)
- Low voltage DC power
(Eliminates the need to replace fuses)
- LED Illumination System
(Accurate color balance, cool to the touch, long bulb life)
- Single Magnification
- Optical Measurement Rings
- Individual Eye-Shields
- Integrated Green Filter
- Adjustable Tension Ball-Joint for Easy 360° Motion

Specifications

- Focal Length: ± 316mm
- Magnification: 9X
- Field Of View: 22mm
- Depth Of Field: 8mm
- Light Intensity: > 25,000LUX
- Working Height: 838mm to 1194mm (33" to 47")
- Power Supply: 90V to 240V
- Warranty: 1 Year - Parts and Labor (excludes shipping charges)

Options

- Additional Extended Warranty



with a 360° rotating Tilt Base

REF CO1100-LED **\$3,395⁰⁰**

1 Year Extended Warranty

REF CO1100-1 **\$295⁰⁰**

2 Year Extended Warranty

REF CO1100-2 **\$415⁰⁰**

	ϕ mm	A	B
		9X	1.5

These circles indicate the millimeter size at the tissue site.

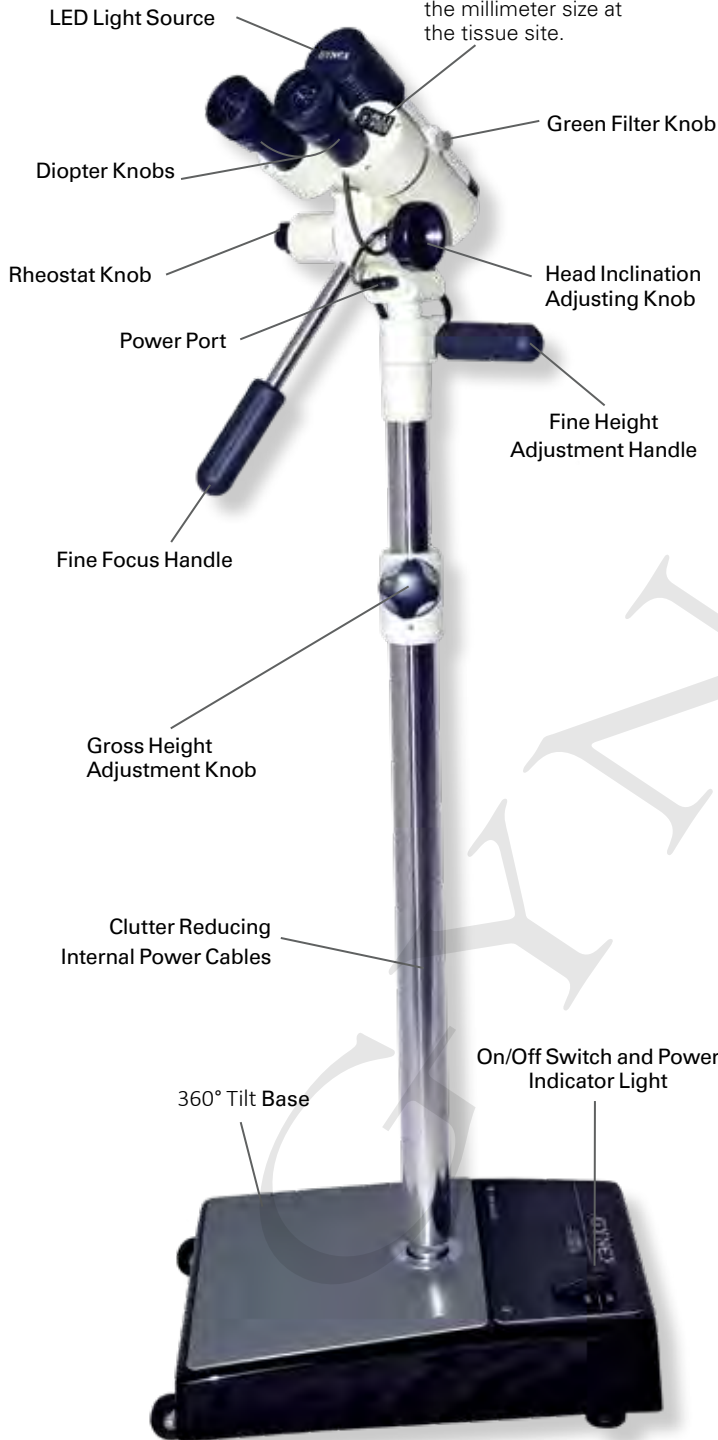

Our colposcopes now utilize low-voltage DC power eliminating the need to replace fuses!



LED Light Source

- Lasts Longer
- Cool To The Touch
- Optimal Color Balance



Universal Teflon Ball Joint

- 360° Easy Maneuver

Galileo® Medical Exam Light

Experience the ultimate convenience and functionality of the Galileo® Medical Exam Light. Its **flexible neck** and adjustable design allow you to position the light exactly where you need it, providing optimal sharp illumination. Its **durable and aesthetically pleasing** design makes it a smart investment for any medical facility.

With **energy-efficient** LED bulb, the Galileo® Medical Exam Light is not only cost-effective but also long-lasting.

Ideal for hospitals, clinics, and private practices, the Galileo® Medical Exam Light is the perfect addition to any medical setting.

Brighter and Cost Effective

- Features 1 white 3W LED for precise, high-output lighting
- Boasts a long lifetime of up to 50,000 hours and provides high illuminance of 70,000 Lux at a 200mm working distance
- Consumes less energy than traditional lighting options
- Eliminate the need for frequent bulb replacement



True-to-Life Color Reproduction

- The lighting is easy on the eyes, providing a comfortable visual experience
- Delivers exceptional color rendering capabilities, ensuring that the illuminated area looks natural and highly contrasted



Adjustable Spot Size

- Offers adjustable spot size with a diameter ranging from 15mm to 220mm, making it suitable for a wide range of situations and working distances, from 200mm to 1000mm
- Easy to clean, ensuring hassle-free maintenance



Flexible Goose Neck

- An extremely flexible goose neck can be securely fixed in any position
- Features a two-segment design that allows for bending at any angle and any directions



Medical Exam Light Accessories

Table Mount

Mount the Galileo® Medical Exam Light to your table for additional floor space.



REF MEL-20\$89⁹⁵

Wall Mount

The Galileo® Medical Exam Light Wall Mount Bracket frees up floor space when necessary.



REF MEL-10\$79⁹⁵



SCAN to SHOP

Invest in the best and choose

Galileo®

REF MEL-50 \$549⁹⁵

Touch-Guard® Single-Use Protective Sheath

Touch-Guard® Single-Use Sheaths protect your medical exam light and reduce the risk of contamination.

- Recommended to use with Galileo® Medical Exam Light REF MEL-50
- Can be used with most goose-neck exam lights under 4cm in diameter

REF TG-300 Box of 25 \$14⁹⁵



Hysterectomy Clamps

Zephyr™ Titanium Rainbow™

Titanium Coated Hysterectomy Clamps

Straight



REF TT580-21	21cm	\$194⁹⁵
REF TT580-24	24cm	\$204⁹⁵
REF TT580-27	27cm	\$214⁹⁵
REF TT580-30	30cm	\$224⁹⁵
REF TT580-36	36cm	\$234⁹⁵

Slight Curve



REF TT585-21	21cm	\$194⁹⁵
REF TT585-24	24cm	\$204⁹⁵
REF TT585-27	27cm	\$214⁹⁵
REF TT585-30	30cm	\$224⁹⁵
REF TT585-36	36cm	\$234⁹⁵

Angled



REF TT595-21	21cm	\$194⁹⁵
REF TT595-24	24cm	\$204⁹⁵
REF TT595-27	27cm	\$214⁹⁵
REF TT595-30	30cm	\$224⁹⁵
REF TT595-36	36cm	\$234⁹⁵

The Original Zephyr™

Stainless Steel Hysterectomy Clamps

Straight



REF 3580-21	21cm	\$114⁹⁵
REF 3580-24	24cm	\$119⁹⁵
REF 3580-27	27cm	\$124⁹⁵
REF 3580-30	30cm	\$129⁹⁵

Slight Curve



REF 3585-21	21cm	\$114⁹⁵
REF 3585-24	24cm	\$119⁹⁵
REF 3585-27	27cm	\$124⁹⁵
REF 3585-30	30cm	\$129⁹⁵

Strong Curve



REF 3590-21	21cm	\$114⁹⁵
REF 3590-24	24cm	\$119⁹⁵
REF 3590-27	27cm	\$124⁹⁵
REF 3590-30	30cm	\$129⁹⁵

Angled



REF 3595-21	21cm	\$114⁹⁵
REF 3595-24	24cm	\$119⁹⁵
REF 3595-27	27cm	\$124⁹⁵
REF 3595-30	30cm	\$129⁹⁵

Hysterectomy Scissors

Titanium Rainbow™ Scissors

Titanium Coated Hysterectomy Scissors



Slight Curve

- REF TT680-20 20cm..... \$97⁹⁵
- REF TT680-23 23cm..... \$99⁹⁵



Full Curve

- REF TT690-20 20cm..... \$97⁹⁵
- REF TT690-23 23cm..... \$99⁹⁵



Curve

- REF TT685-20 20cm..... \$97⁹⁵
- REF TT685-23 23cm..... \$99⁹⁵



Angled

- REF TT695-20 20cm..... \$97⁹⁵
- REF TT695-23 23cm..... \$99⁹⁵

Zephyr™ Scissors

Stainless Steel Hysterectomy Scissors



Curve Scissors

- REF 3685-20 20cm..... \$97⁹⁵
- REF 3685-23 23cm..... \$99⁹⁵



Angled Scissors

- REF 3695-20 20cm..... \$97⁹⁵
- REF 3695-23 23cm..... \$99⁹⁵



Slight Curve Scissors

- REF 3680-20 20cm..... \$97⁹⁵
- REF 3680-23 23cm..... \$99⁹⁵



Full Curve Scissors

- REF 3690-20 20cm..... \$97⁹⁵
- REF 3690-23 23cm..... \$99⁹⁵

Scissors

Iris Scissors

Straight

REF S3816
11cm Length.....\$36⁹⁵



Curved

REF S3814
11cm Length.....\$39⁹⁵



Angled

REF S3812
11cm Length.....\$42⁹⁵



Littaur Stitch Scissors

REF S3810 14cm Length.....\$27⁹⁵



Laminaria Insertion Forceps

Specifically designed for insertion of laminaria.

REF 1600\$79⁹⁵



Needle Holders

Webster Smooth Needle Holder

Smooth jaw

REF NHW3400 13cm Length.....\$34⁹⁵



Mayo-Hegar Needle Holder

Serrated jaw

REF NHMH3410-14 14cm Length.....\$34⁹⁵
REF NHMH3410-16 16cm Length.....\$37⁹⁵
REF NHMH3410-18 18cm Length.....\$39⁹⁵
REF NHMH3410-20 20cm Length.....\$42⁹⁵



Crile-Wood Needle Holder

Serrated jaw

REF NHCW3420-15 15cm Length.....\$37⁹⁵
REF NHCW3420-18 18cm Length.....\$39⁹⁵
REF NHCW3420-20 20cm Length.....\$42⁹⁵
REF NHCW3420-23 23cm Length.....\$47⁹⁵



Electrode Extender

Effectively Doubles the Shaft Length of Your Electrode

STERILE EO **Single-Use** 

Not made with natural rubber latex.

REF **12-0000** 13cm Length
Box of 5 **\$47⁹⁵**



**ACCESS DEEP CAVITIES
AND OTHER
HARD-TO-REACH SITES**



Electrode Handpiece, Hand Activated with VL Plug

For use with standard removable electrodes

STERILE EO **Single-Use** 

Not made with natural rubber latex.

10 foot cable
REF **755VL** Box of 12..... **\$109⁹⁵**



Electrode Handpiece, Foot Activated

For use with standard removable electrodes

STERILE EO **Single-Use** 

Not made with natural rubber latex.

10 foot cable
REF **950** Box of 12..... **\$84⁹⁵**



Actual size

Radius Loop Electrodes

Our Most Popular Style

STERILE EO Single-Use[®]
Not made with natural rubber latex.

All Electrode Tips Shown at Actual Size

REF 12-0505 5mm x 5mm
Box of 5..... \$68⁹⁵



REF 12-1007 10mm x 7mm
Box of 5..... \$68⁹⁵



REF 12-1010 10mm x 10mm
Box of 5..... \$68⁹⁵



REF 12-1505 15mm x 5mm
Box of 5..... \$68⁹⁵



REF 12-1508 15mm x 8mm
Box of 5..... \$68⁹⁵



REF 12-1512 15mm x 12mm
Box of 5..... \$68⁹⁵

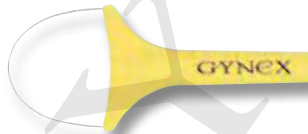

REF 12-1515 15mm x 15mm
Box of 5..... \$68⁹⁵

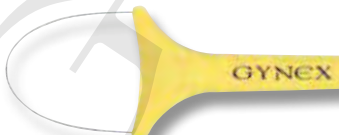

REF 12-2008 20mm x 8mm
Box of 5..... \$68⁹⁵



REF 12-2010 20mm x 10mm
Box of 5..... \$68⁹⁵



REF 12-2013 20mm x 13mm
Box of 5..... \$68⁹⁵



REF 12-2015 20mm x 15mm
Box of 5..... \$68⁹⁵



REF 12-2510 25mm x 10mm
Box of 5..... \$68⁹⁵



REF 12-2515 25mm x 15mm
Box of 5..... \$68⁹⁵



Electrode Measurements

REF 12-2015
Width Height

WHAT REFERENCE NUMBERS MEAN

H-Series Loop Electrodes

Precision Depth and Width Control

STERILE EO **Single-Use**
 Not made with natural rubber latex.

REF 13-1505 15mm x 5mm
 Box of 5 **\$68⁹⁵**

REF 13-2005 20mm x 5mm
 Box of 5 **\$68⁹⁵**

REF 13-1010 10mm x 10mm
 Box of 5 **\$68⁹⁵**



REF 13-2007 20mm x 7mm
 Box of 5 **\$68⁹⁵**

REF 13-2010 20mm x 10mm
 Box of 5 **\$68⁹⁵**

Needle Electrode

For electro fulguration using coagulation power outputs

STERILE EO **Single-Use**
 Not made with natural rubber latex.



REF 15-0001 26mm Long Needle
 Box of 5 **\$68⁹⁵**

All Electrode Tips Shown at Actual Size

Square Loop Electrodes

STERILE EO **Single-Use**
 Not made with natural rubber latex.



REF 19-1004 10mm x 4mm
 Box of 5 **\$68⁹⁵**



REF 19-1010 10mm x 10mm
 Box of 5 **\$68⁹⁵**

Ball Electrodes

Ideal for hemostasis of bleeding sites and/or ablation of sub-surface lesions

STERILE EO **Single-Use**
 Not made with natural rubber latex.

REF 2-3-2 3mm Diameter, 13.5cm Shaft
 Box of 5 **\$67⁹⁵**

REF 2-5-2 5mm Diameter, 13.5cm Shaft
 Box of 5 **\$67⁹⁵**

GYNEX® Cone Electrodes

STERILE EO Single-Use

Not made with natural rubber latex.

The Cone Electrode is a LLETZ excisor for precise cone biopsy specimens

Cone biopsy electrodes allow for smooth rotation, facilitating the removal of precise, cone-shaped specimens. The tungsten linear wires are 0.20mm thick to help reduce backward drag. Molded shaft and stop arm are completely insulated to protect the endocervical canal and underlying vaginal structures.

Each electrode is packaged in a molded blister tray which keeps the tip true to shape and protects from breakage.

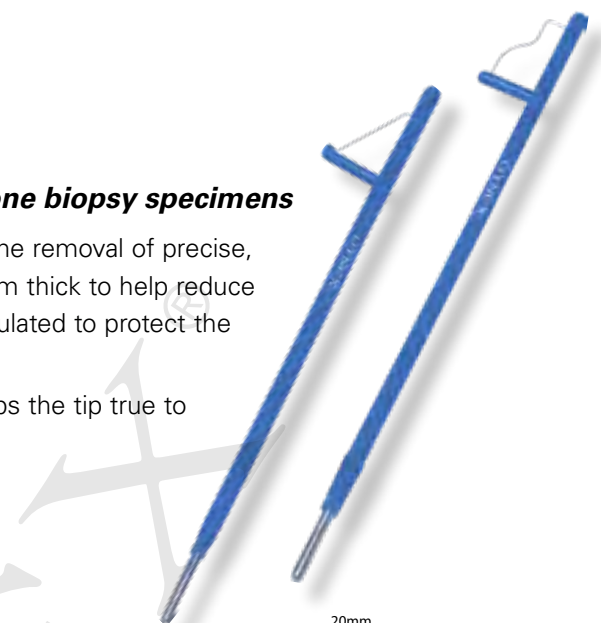

Triangle Cone Electrode

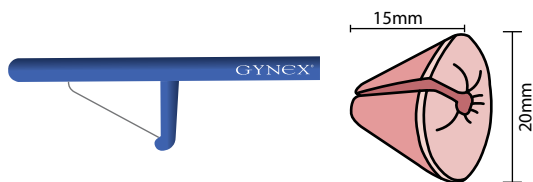

REF 14-1015 10mm Radius x 15mm Height
Box of 5.....\$68⁹⁵



REF 14-1020 10mm Radius x 20mm Height
Box of 5.....\$68⁹⁵

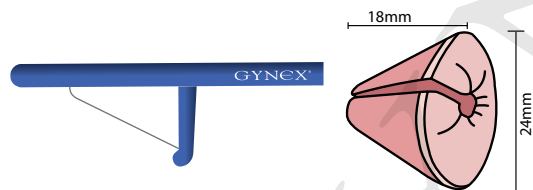

REF 14-1218 12mm Radius x 18mm Height
Box of 5.....\$68⁹⁵

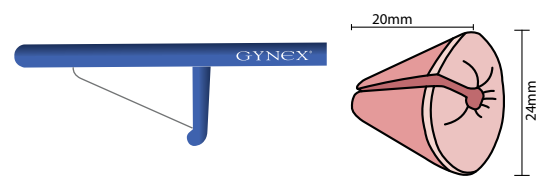

REF 14-1220 12mm Radius x 20mm Height
Box of 5.....\$68⁹⁵

Contoured Cone Electrode



REF 17-1013 10mm Radius x 13mm Height
Box of 5.....\$68⁹⁵



REF 17-1018 10mm Radius x 18mm Height
Box of 5.....\$68⁹⁵

Electrosurgical Patient Dispersive Pads

for LLETZ Procedures

NON-STERILE Single-Use®
Not made with natural rubber latex.

Standard Grounding Pad with Cord, Solid-Style

Generators Compatibility

MANUFACTURES	PAD REF #
BEI® Plus II	395-302
CooperSurgical® LEEP® 1000	6050P
CooperSurgical® LEEP® 6000	6050P



Connector shown at ACTUAL SIZE



REF 6010

Box of 12 \$99⁹⁵

Grounding Pad with Cord, Solid-Style

Generators Compatibility

MANUFACTURES	PAD REF #
Utah Medical Finess II	
Utah Medical Finess®	ESU-405



Connector shown at ACTUAL SIZE



REF 21-809

Box of 12 \$99⁹⁵

Grounding Pad with Cord, Split (REM)

Generators Compatibility

MANUFACTURES	PAD REF #
ConMed® Sabre® 180	402-2204
Wallach® Quantum 2000, 500	909078
Utah Medical Finess® II*	ESU-420
Utah Medical Finess® +	



Connector shown at ACTUAL SIZE



REF 33-714

Box of 12 \$99⁹⁵

SHOP ONLINE

SCAN QR-CODE TO VISIT WEBSITE

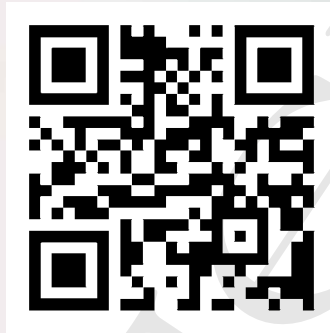

www.gynex.com

Extended Needle Adapters, Luer Hub, REUSABLE

Extends the reach of hypodermic needles

Stainless Steel

Available Size: 3–6 inch lengths

REF 5120 7.62cm (3") **\$37⁹⁵**



REF 5122 10.16cm (4") **\$37⁹⁵**



REF 5124 12.7cm (5") **\$37⁹⁵**



REF 5126 15.24cm (6") **\$37⁹⁵**

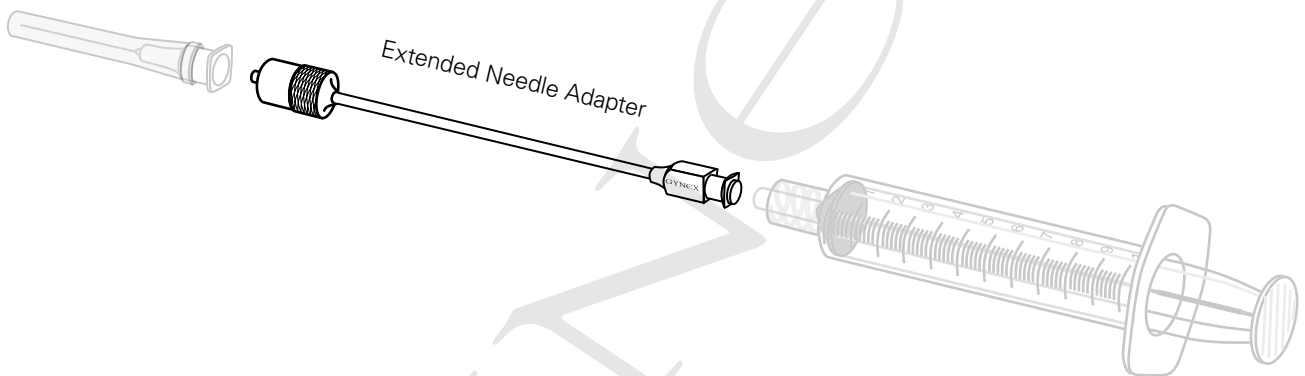

Cartridge Syringe, Screw Hub, REUSABLE

NOTE: This does not work with the Extended Needle Adapter shown above.

REF 5210 **\$54⁹⁵**



Filter, Prefilter and Reducer

for Smoke Evacuation Systems

Sterile Vacuum Tubing Sets, Single-Use

STERILE EO Single-Use

Not made with natural rubber latex.

Fits most smoke evacuation systems that use 1/2" OD.
The 9'+ tubing is connected to DSE tubing which connects to the speculum as shown in the illustration above.

REF 8200 12 Sets..... **\$199⁹⁵**



Perfect match for all smoke evacuators at a far more **reasonable price!**

Prefilter Reducer, Single-Use

NON-STERILE Single-Use

Not made with natural rubber latex.

Fits into top of Prefilter (REF 8210), and adapts to .375" ID tubing (REF 8200 Tubing Set)

- Bottom opening is 1.33" OD
- Top opening is .375" OD
- Fits CooperSurgical 6080 Smoke Evacuator, with 8210 Prefilter

REF 8230 Qty 10 **\$54⁹⁵**

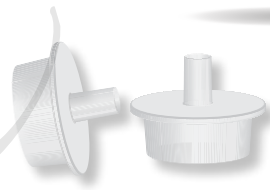

CONNECTS WITH

Prefilter, Single-Use

NON-STERILE Single-Use

Not made with natural rubber latex.

- Fits CooperSurgical 6080 Smoke Evacuator
- Top opening is 1.33" ID
- Non-combustible

REF 8210 Qty 10 **\$197⁹⁵**



CONNECTS WITH

ULPA Filter, Single-Use

NON-STERILE Single-Use

Not made with natural rubber latex.

- Maximum Life 90 Days
- Fits CooperSurgical 6080 Smoke Evacuator

REF 8215 **\$194⁹⁵** each



Tubing and Connectors

for LLETZ Procedures

Tubing Connector

NON-STERILE Single-Use

Not made with natural rubber latex.

Connects Clear-Flue™ to Flexible-S Tubing. 1/4" to 7/8"

REF 8100 Box of 12.... \$27⁹⁵

Flexible-S Tubing

NON-STERILE Single-Use

Not made with natural rubber latex.

Connects to DSE Tubing. 1/4" ID, 3/8" OD x 2'

REF 8024 Box of 6..... \$47⁹⁵

DSE Tubing

NON-STERILE Single-Use

Not made with natural rubber latex.

Attaches to specula with smoke evacuation clip.

Non-combustible, No PVC. 1/4" OD x 9"

REF 8009 Box of 50..... \$92⁹⁵

Clear-Flue™ Tubing

NON-STERILE Single-Use

Not made with natural rubber latex.

Attaches to either Flexible-S Tubing or to Sterile Vacuum Tubing. 7/8" OD x 66"

REF 8072 Qty 24..... \$77⁹⁵

Tubing Connector

NON-STERILE Single-Use

Not made with natural rubber latex.

Connects Clear-Flue™ to Sterile Vacuum Tubing. 3/8" to 7/8"

REF 8103 Box of 12.... \$27⁹⁵

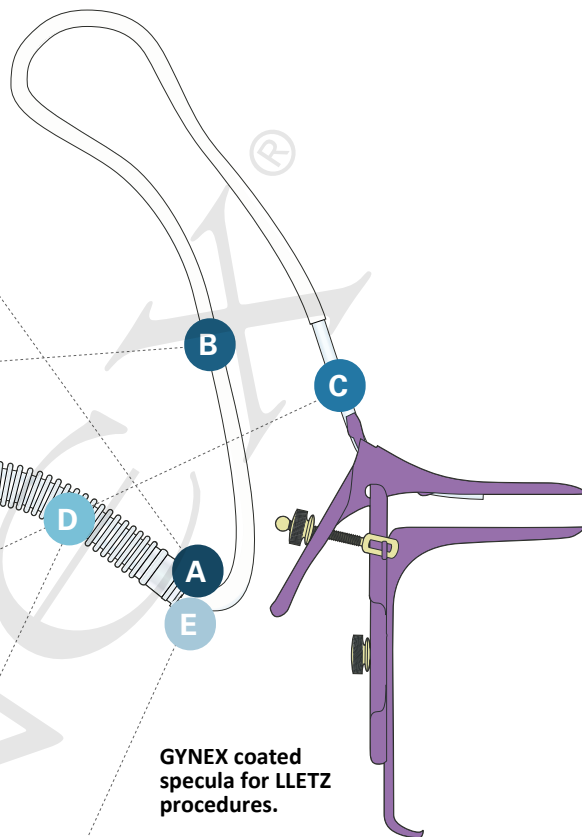
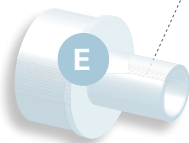
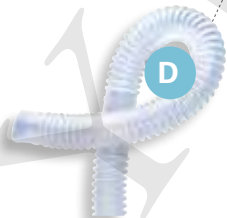
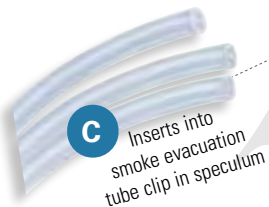
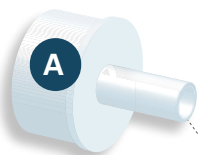

Sterile Vacuum Tubing Sets, Single-Use

STERILE EO Single-Use

Not made with natural rubber latex.

Fits many popular smoke evacuation systems that use 1/2" OD. The 9'+ tube is connected to DSE tubing which connects to the speculum as shown in the illustration above.

REF 8200 12 Sets... \$199⁹⁵

CONNECTS WITH

CONNECTS WITH

Sponge Forceps, Single-Use

NON-STERILE Single-Use

Not made with natural rubber latex.

Length: 24cm

REF 3207 12-Pack..... \$42⁹⁵

REF 3214 24-Pack \$79⁹⁵

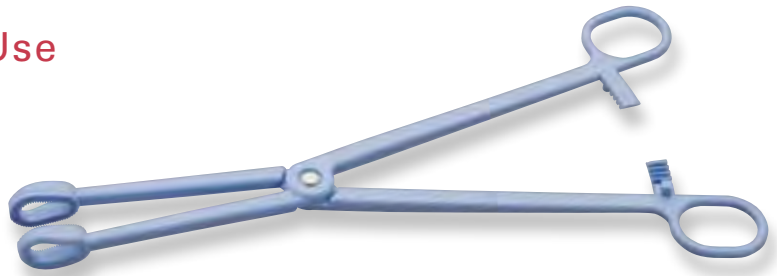

Topical Anesthetic

HurriCaine® Topical Anesthetic Snap-n-Go™ Swabs

Box of 72

- Fast onset - 20 seconds
- Dose .15ml

See product details from manufacturer.

Beutlich® Pharmaceuticals, LLC

REF 0569 \$59⁹⁵



HurriCaine® Topical Anesthetic Spray Kit

2oz Spray Container

- Provides 200 one second applications
- Includes 200 Single-Use extension tubes

See product details from manufacturer.

Beutlich® Pharmaceuticals, LLC

REF 0183 \$79⁹⁵



LLETZ Instruments

LLETZ-Coated Tenaculum

Coated Stainless Steel

Length: 25cm

Braun LiteTouch™ Tenaculum

Atraumatic design

Closed position, tips overlap 1-2 mm

REF LT2250 **\$159⁹⁵**

Braun Standard Tenaculum

Tips overlap 4-6 mm. ±1 mm

REF 3249 **\$159⁹⁵**

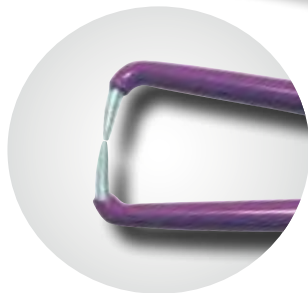
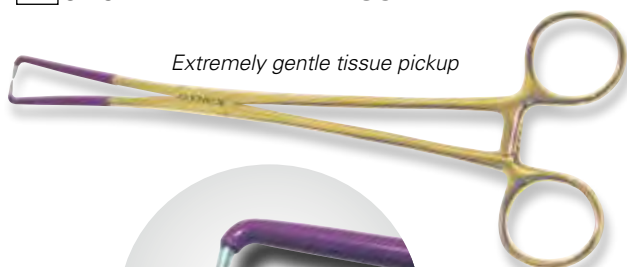

LLETZ-Coated Tissue Forceps

Coated Stainless Steel

Length: 21.5cm

REF 3205 **\$109⁹⁵**

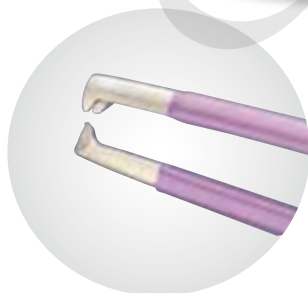

LLETZ-Coated Hooks

Coated Stainless Steel

Length: 26cm on all hooks

Iris Hook

REF 3230 **\$99⁹⁵**

Emmett Tenaculum

REF 3240 **\$99⁹⁵**

Angle Hook

REF 3245 **\$99⁹⁵**

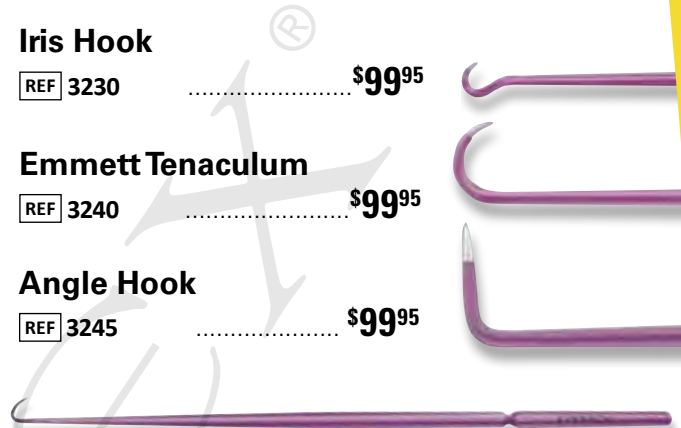

LLETZ-Coated Rulers

Depth Ruler

Coated Stainless Steel

- Millimeter markings, center at 5mm

Length: 24cm

REF 3250 **\$119⁹⁵**



Width Ruler

Coated Stainless Steel

- Millimeter markings

Length: 22cm

REF 3255 **\$119⁹⁵**



Vaginal Speculum, LLETZ COATED

4-Way Expander Vaginal Speculum

The 4-Way Expander Vaginal Speculum is designed for LLETZ procedures with Gynex's lavender non-conductive coating. It provides a superior view with one instrument as compared to a standard speculum and lateral retractor. The built-in side blades are erected to enhance the view of the cervix as needed.

Features

- Built-in smoke evacuation tube holder
- Built-in lateral retractor blades
- Side blades lock firmly into place
- Pederson size blades

Medium

REF L4MEX 115mm..... **\$269⁹⁵**

Large

REF L4LEX 125mm **\$274⁹⁵**

OK to Autoclave

LLETZ Coated

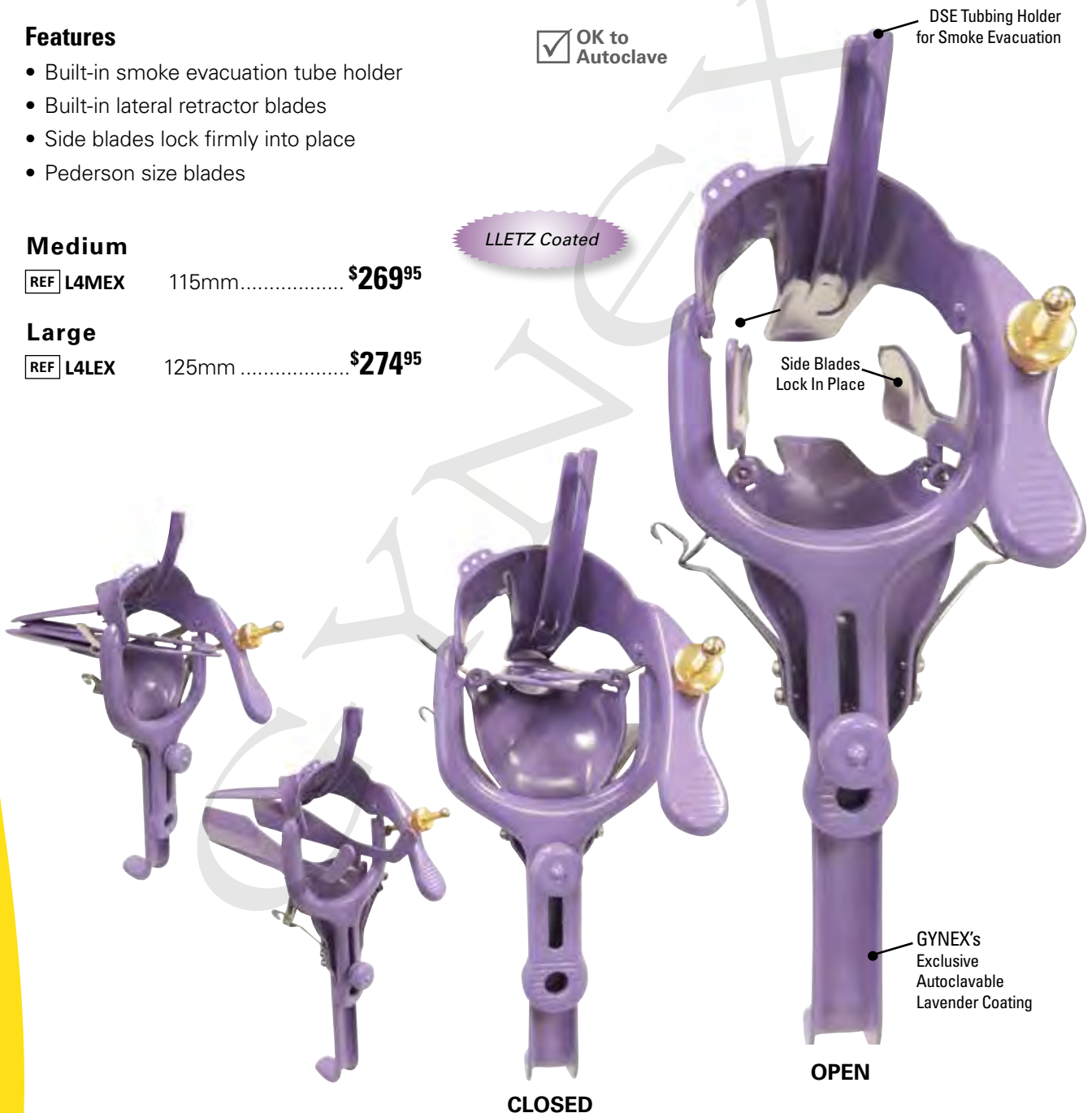

Lateral Vaginal Retractor

Control side wall collapse during electrosurgery with a GYNEX LLETZ-Coated Lateral Vaginal Retractor. It provides the extra access and visibility needed during electrosurgery procedures of the cervix. This instrument features GYNEX's exclusive autoclavable lavender coating, providing extra durability and safety.

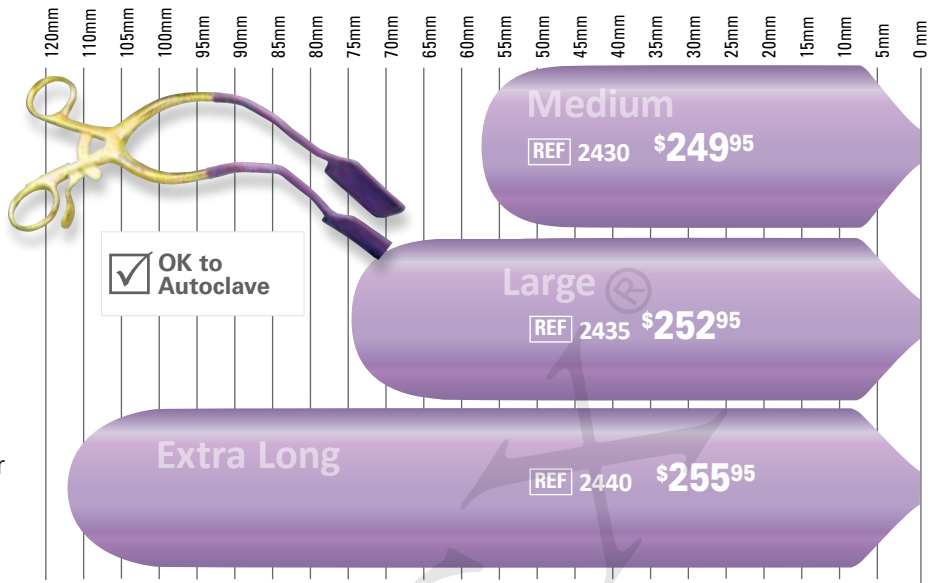

Blade Reference Chart: Shown Actual Size, Scale 1:1

LLETZ Open-Sided Speculum

Left and Right Opening

Blade Reference Chart: Shown Actual Size, Scale 1:1

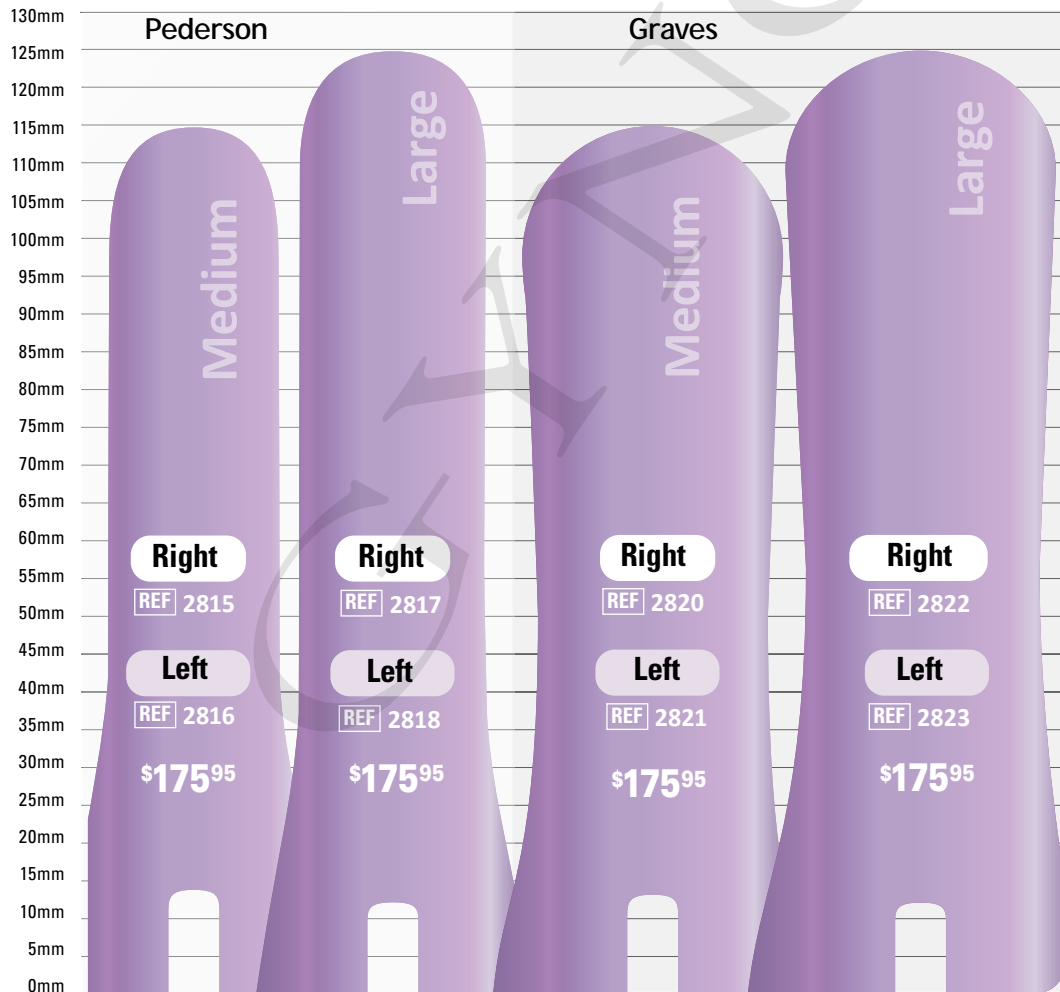

Don't Forget to Order Your DSE Smoke Evacuation Tubing for Your LLETZ Specula (see pages 72-73)

LLETZ Coated



OK to Autoclave

5% Discount on Prepaid Orders by Check or ACH payment (offer excludes microscopes, colposcopes and/or extended warranties).

Sullivan Vaginal Speculum

Features

- Unique C-Arm maximizes your view
- Easy one handed open and release
- Locks firmly into place

LLETZ Coated



Ideal for bariatric patients

Blade Reference Chart: Shown Actual Size, Scale 1:1



*Ideal to use with
a Lateral Vaginal
Retractor as there are
no side obstructions
like most specula*

OK to
Autoclave

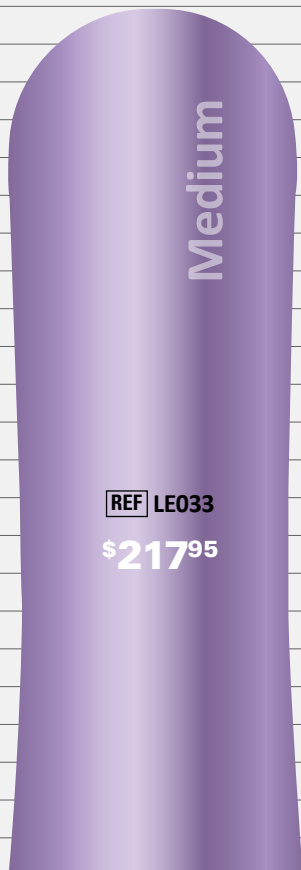

Pederson & Graves Speculum

LLETZ Coated

OK to Autoclave

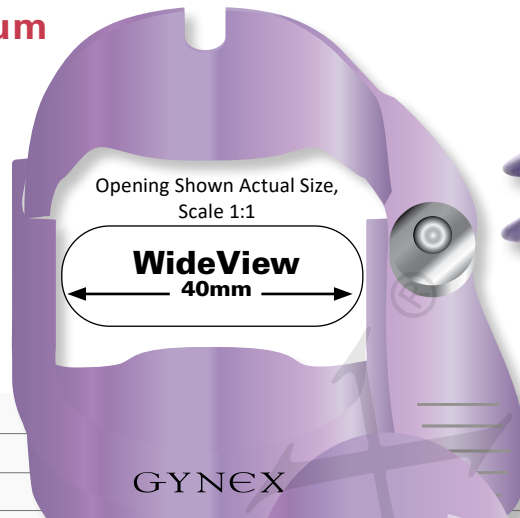

Blade Reference Chart: Shown Actual Size, Scale 1:1

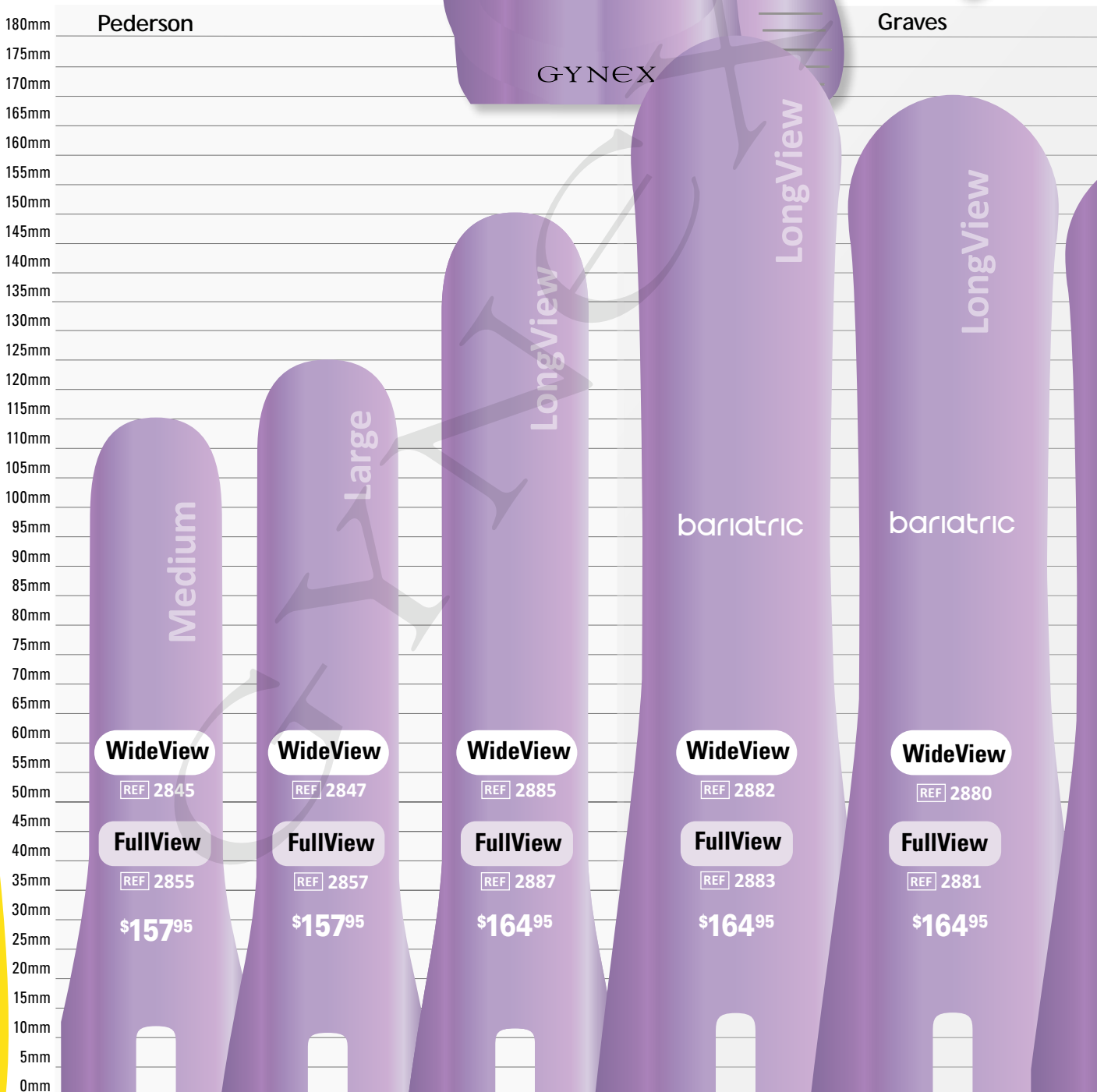

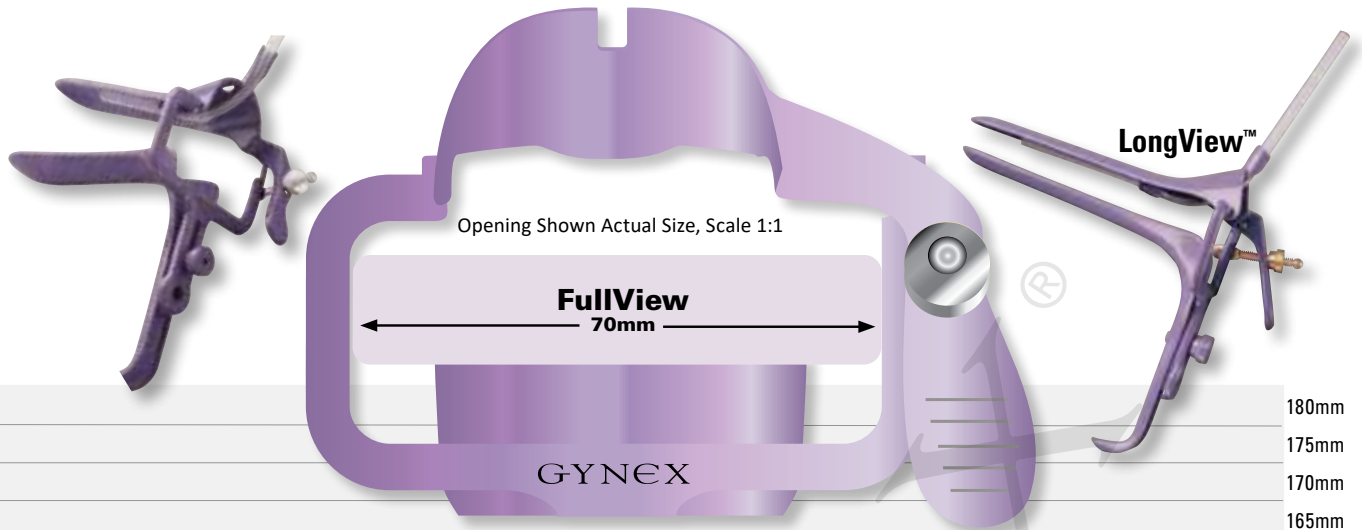

180mm
175mm
170mm
165mm
160mm
155mm
150mm
145mm
140mm
135mm
130mm
125mm
120mm
115mm
110mm
105mm
100mm
95mm
90mm
85mm
80mm
75mm
70mm
65mm
60mm
55mm
50mm
45mm
40mm
35mm
30mm
25mm
20mm
15mm
10mm
5mm
0mm

LongView

bariatric

WideView
REF 2878

FullView
REF 2879
\$164⁹⁵

LongView

WideView
REF 2875

FullView
REF 2877
\$164⁹⁵

Large

WideView
REF 2842

FullView
REF 2852
\$157⁹⁵

Medium

WideView
REF 2840

FullView
REF 2850
\$157⁹⁵

Short

WideView
REF 2830
\$157⁹⁵

Vaginal Speculum, STAINLESS

Pederson & Graves Speculum

Stainless Steel

Blade Reference Chart:

Shown Actual Size, Scale 1:1

Opening Shown Actual Size, Scale 1:1

Standard

← 30mm →

GYNEX

Graves

LongView

LongView

LongView

Large

Medium

Small (virginal)

bariatric

bariatric

Standard

REF 2457

\$34⁹⁵

Standard

REF 2459

\$34⁹⁵

WideView

REF 2500

\$44⁹⁵

WideView

REF 2525

\$44⁹⁵

WideView

REF 2785

\$62⁹⁵

WideView

REF 2782

\$62⁹⁵

WideView

REF 2780

\$62⁹⁵

FullView

REF 2600

\$44⁹⁵

FullView

REF 2625

\$44⁹⁵

FullView

REF 2787

\$62⁹⁵

FullView

REF 2783

\$62⁹⁵

FullView

REF 2781

\$62⁹⁵

Small Standard*

*opening 25mm

REF 2455

\$34⁹⁵

180mm
175mm
170mm
165mm
160mm
155mm
150mm
145mm
140mm
135mm
130mm
125mm
120mm
115mm
110mm
105mm
100mm
95mm
90mm
85mm
80mm
75mm
70mm
65mm
60mm
55mm
50mm
45mm
40mm
35mm
30mm
25mm
20mm
15mm
10mm
5mm
0mm

Pederson

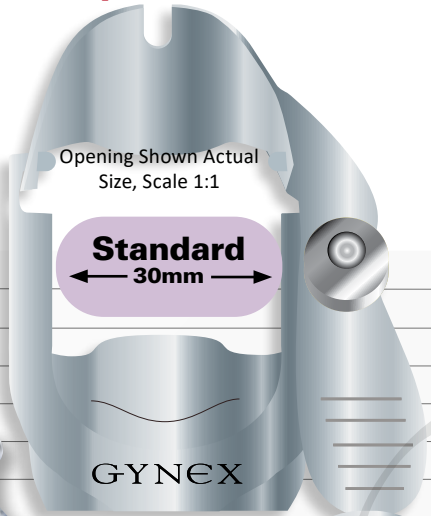

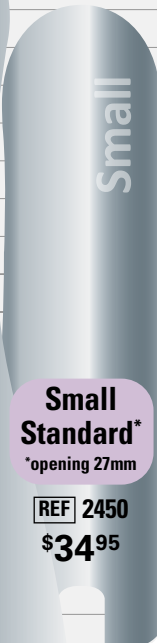
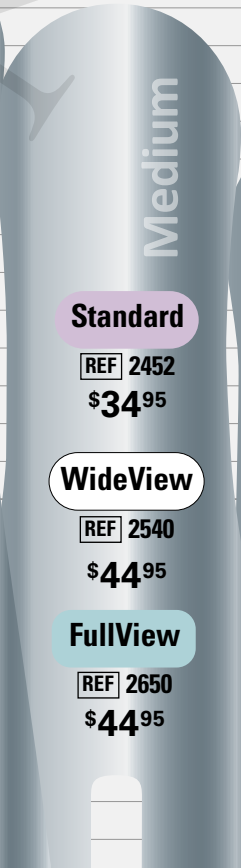
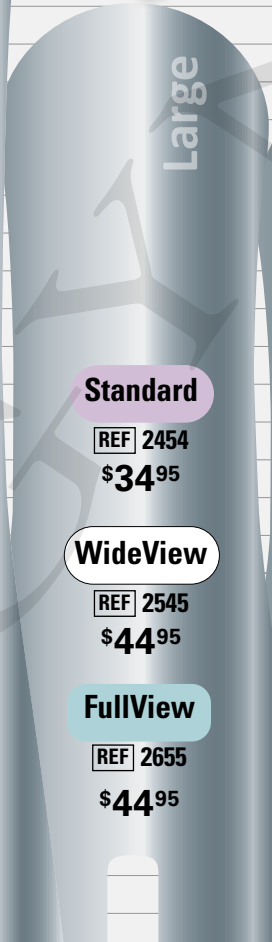
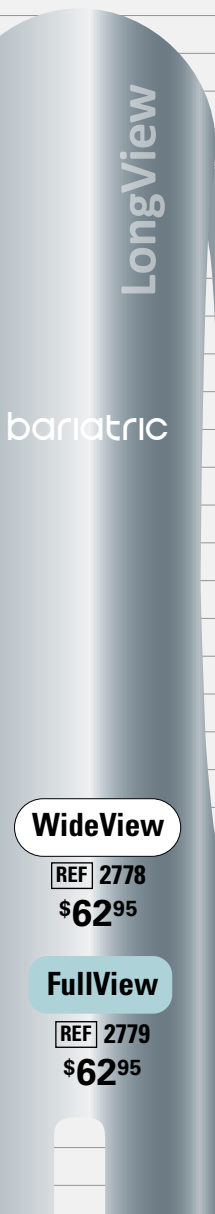
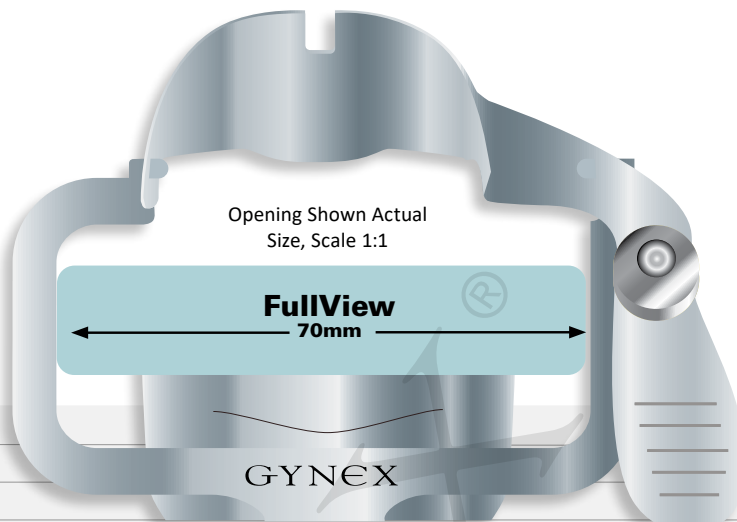
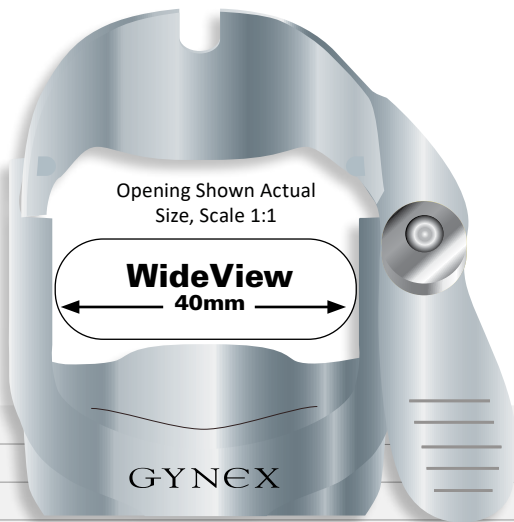

- 180mm
- 175mm
- 170mm
- 165mm
- 160mm
- 155mm
- 150mm
- 145mm
- 140mm
- 135mm
- 130mm
- 125mm
- 120mm
- 115mm
- 110mm
- 105mm
- 100mm
- 95mm
- 90mm
- 85mm
- 80mm
- 75mm
- 70mm
- 65mm
- 60mm
- 55mm
- 50mm
- 45mm
- 40mm
- 35mm
- 30mm
- 25mm
- 20mm
- 15mm
- 10mm
- 5mm
- 0mm

Standard
REF 2454
\$34⁹⁵

Standard
REF 2452
\$34⁹⁵

WideView
REF 2545
\$44⁹⁵

WideView
REF 2540
\$44⁹⁵

WideView
REF 2530
\$44⁹⁵

FullView
REF 2655
\$44⁹⁵

FullView
REF 2650
\$44⁹⁵

Small Standard*
*opening 27mm
REF 2450
\$34⁹⁵

WideView
REF 2778
\$62⁹⁵

WideView
REF 2775
\$62⁹⁵

FullView
REF 2779
\$62⁹⁵

FullView
REF 2777
\$62⁹⁵

Sullivan Speculum

Features

- Unique C-Arm maximizes your view
- Easy one handed open and release
- Locks firmly into place

Ideal for bariatric patients

Stainless Steel



Blade Reference Chart: Shown Actual Size, Scale 1:1

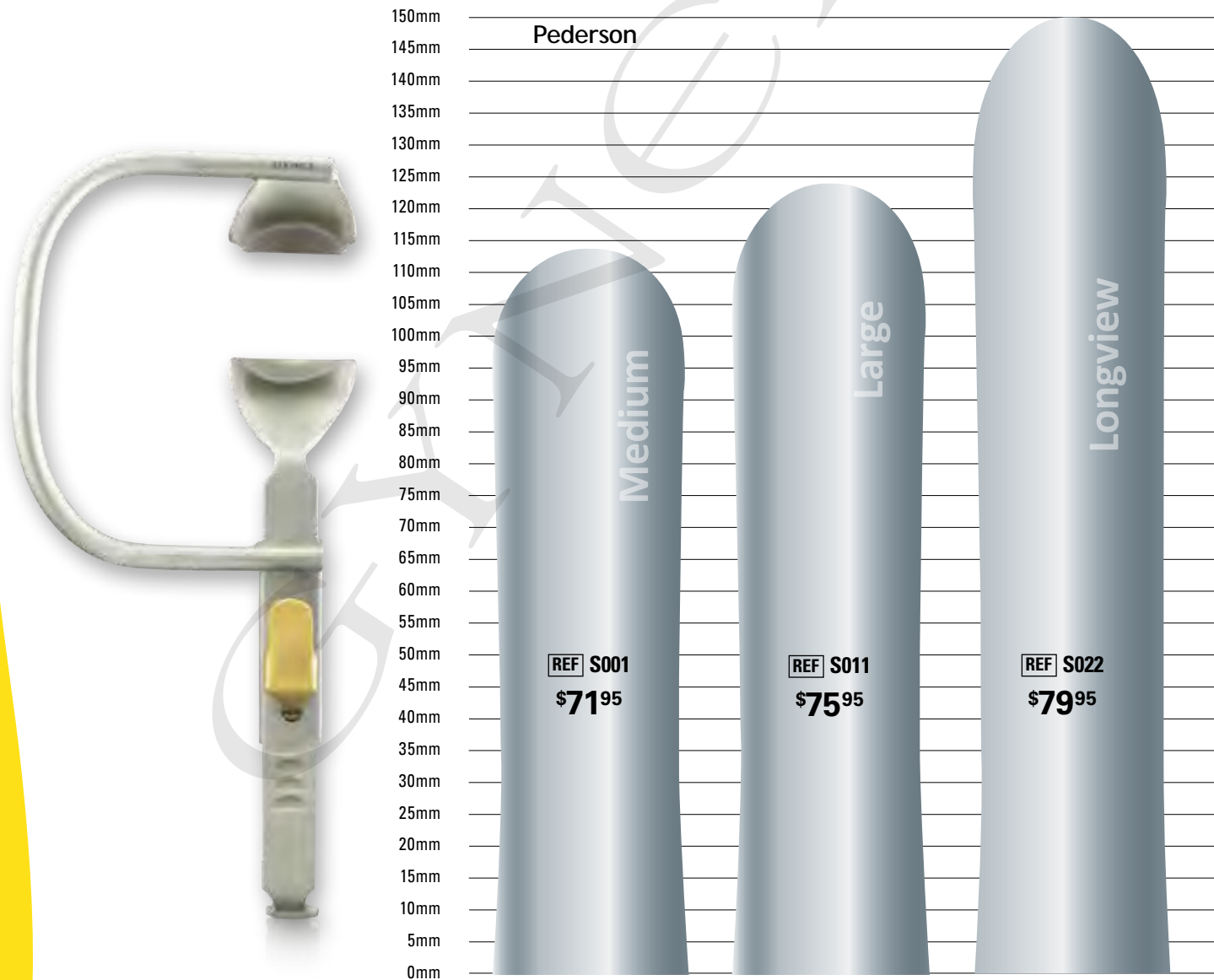

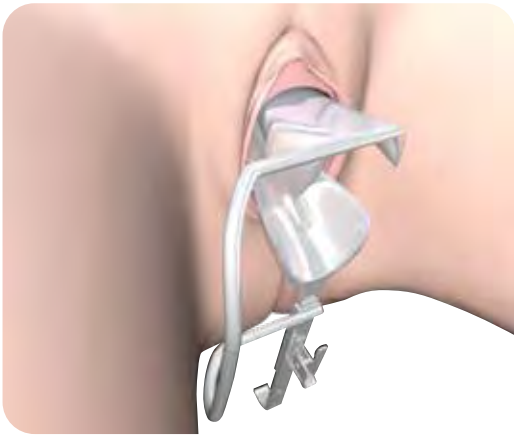

C-Arm is designed to parallel the contour of the patient's leg



No side obstruction like most specula

Graves

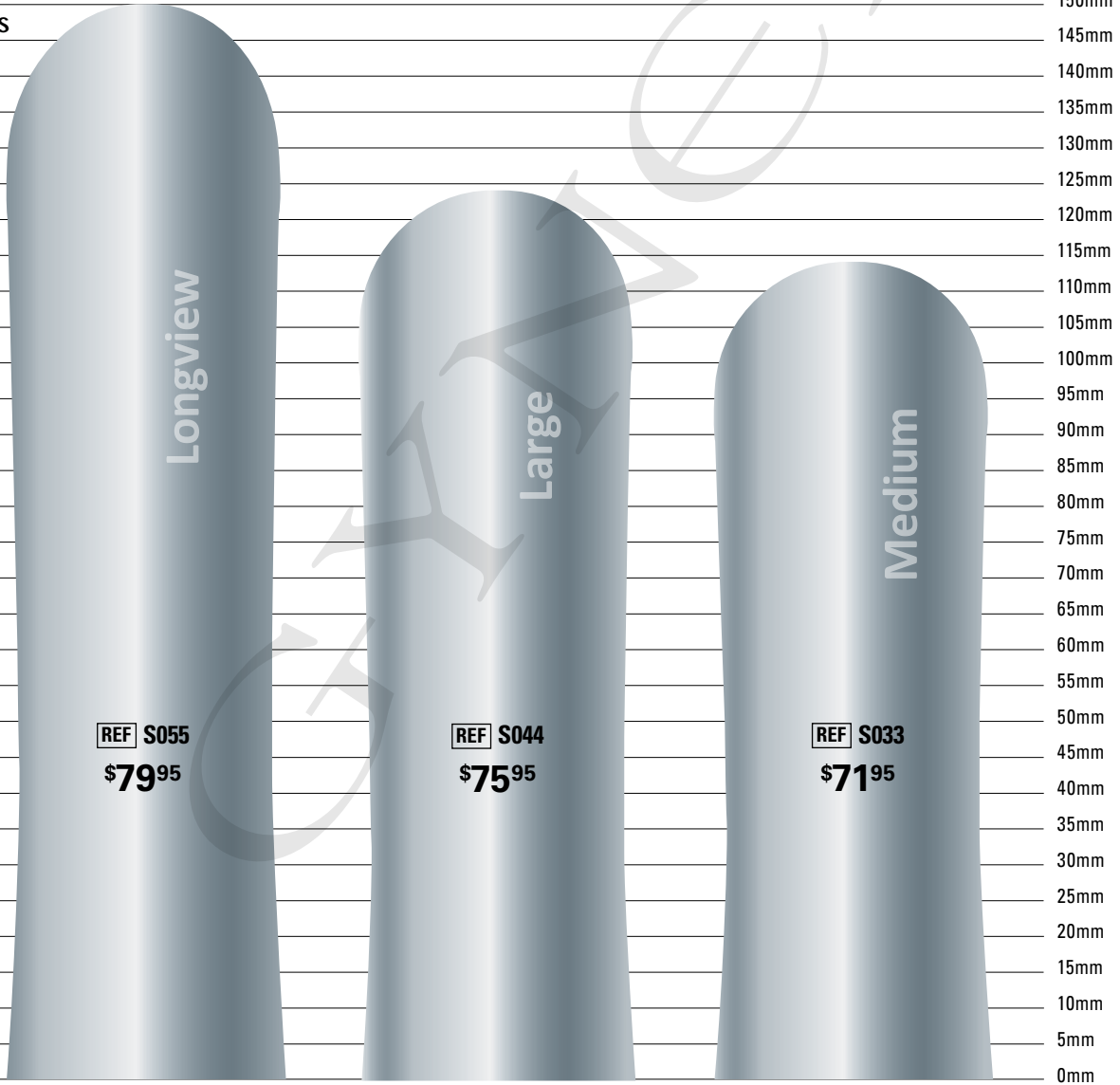

5% Discount on Prepaid Orders by Check or ACH payment (offer excludes microscopes, colposcopes and/or extended warranties).

Lateral Vaginal Retractor

Control side wall collapse and get more cervical access with a GYNEX® Stainless Lateral Vaginal Retractor. For unparalleled ease of use and variety of practical sizes, nothing compares with GYNEX® Stainless Lateral Vaginal Retractor.

Compatible with GYNEX® Wide-View™ and FullView™ Specula

- Lateral vaginal retractors fit inside the speculum providing greater visibility and access to the cervix

Stainless Steel

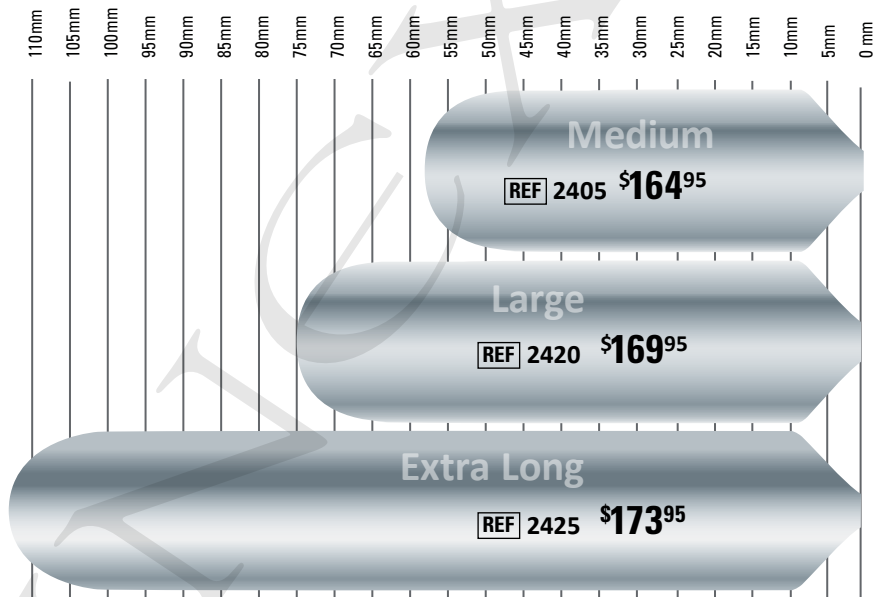

Blade Reference Chart: Shown Actual Size, Scale 1:1



Auvard Weighted Speculum

Single-end vaginal speculum designed to be used during vaginal surgery (hysterectomy, dilation and curettage) with the patient in the lithotomy position. The weight holds the speculum in place to provide an open view.

Fixed Weight: 1.4 kg

Size: 105mm long x 38mm wide

REF SA2200 **\$299.95**

Guttman Speculum with Special Blades

This indispensable speculum operates without upper blades, permitting total visualization of the cervix & vagina. Two separators aid in the opening and stabilizing the vagina.

Medium

REF 2310 Top Separator: 82mm **\$69⁹⁵**

Large

REF 2312 Top Separator: 92mm..... **\$69⁹⁵**



Greenberg Hysteroscopy Speculum

The Greenberg Hysteroscopy Speculum is a modified traditional open-sided Graves speculum with shorter blades and an open side allowing removal of instruments while they are still in the vagina. This speculum brings the patient's cervix closer to the provider and reduces the length of unsupported hysteroscope shaft entering the cervical canal.

REF 2801 **\$56⁹⁵**



"The shorter blades bring the external os about 30% closer to the introitus and make access to the cervix dramatically easier in almost every facet of surgical cases in which a speculum is used."

James Greenberg, MD,
Boston, MA

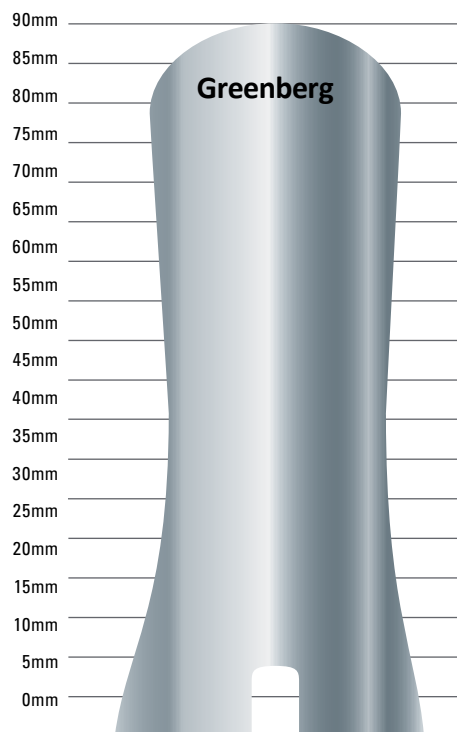
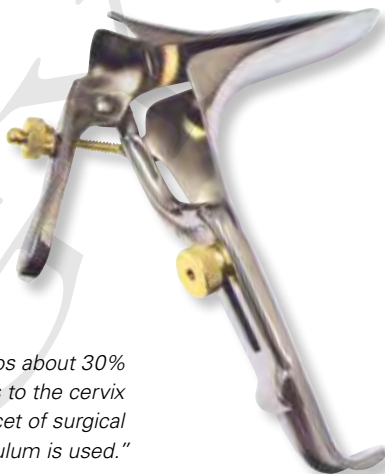

Open-Sided Stainless Steel Speculum

Left and Right Opening

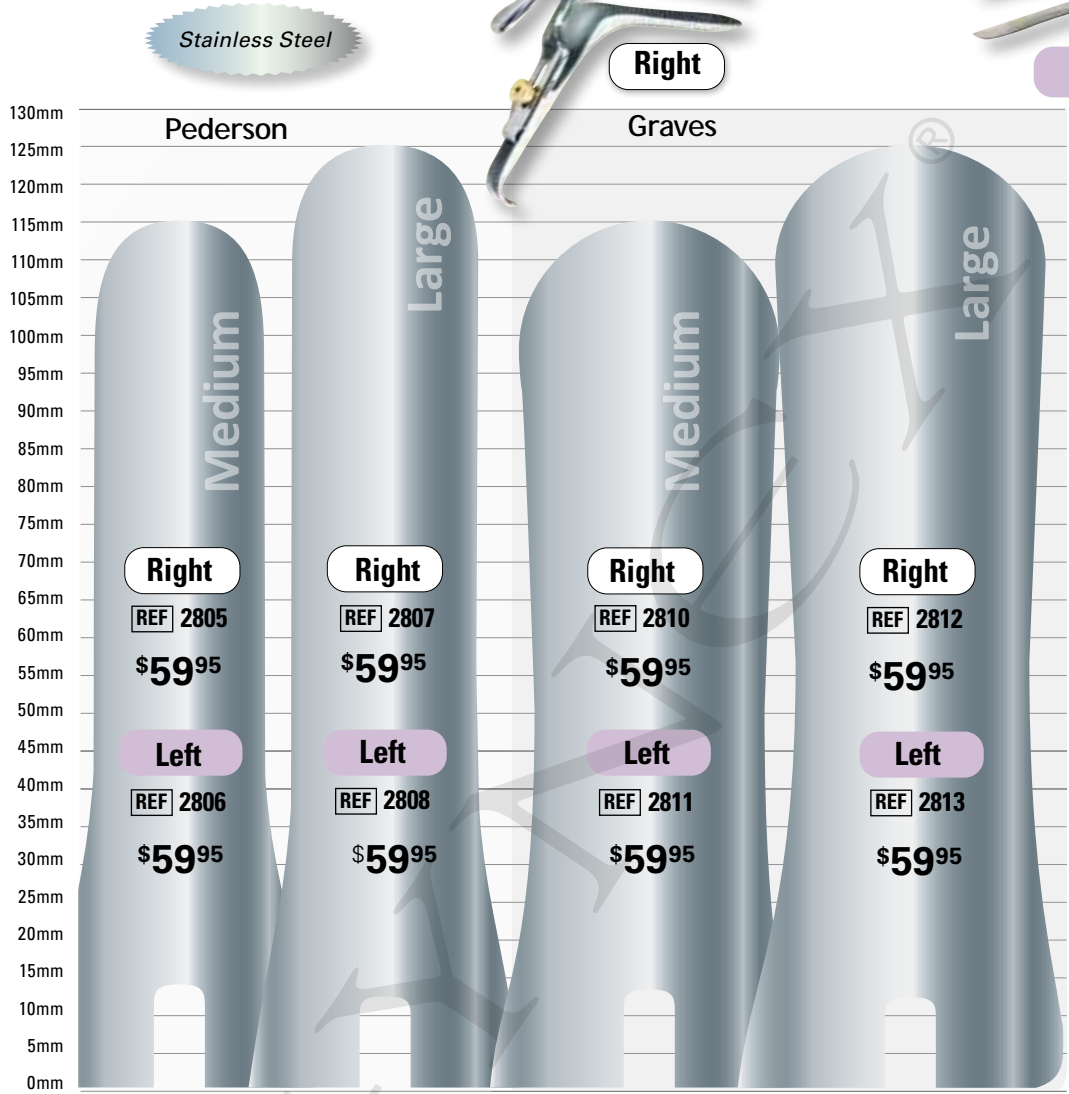

Note: Blade length is measured from top center of back of blade to end of distal tip. In most cases, the bottom speculum blade will protrude and appear to be longer. Mechanical assembly of a speculum simply places the bottom blade in a more forward position. Although the two blades are normally similar in length, they may vary a few millimeters from lot to lot.

Titanium Rainbow™ Speculum

Exclusive Titanium Rainbow™ coating extends the life of instruments over traditional stainless-steel. The titanium coated speculum offers increased resistance to corrosion, resilience against impact and low friction coefficient. Titanium Rainbow™ is available in two viewing widths for Pederson and Graves.

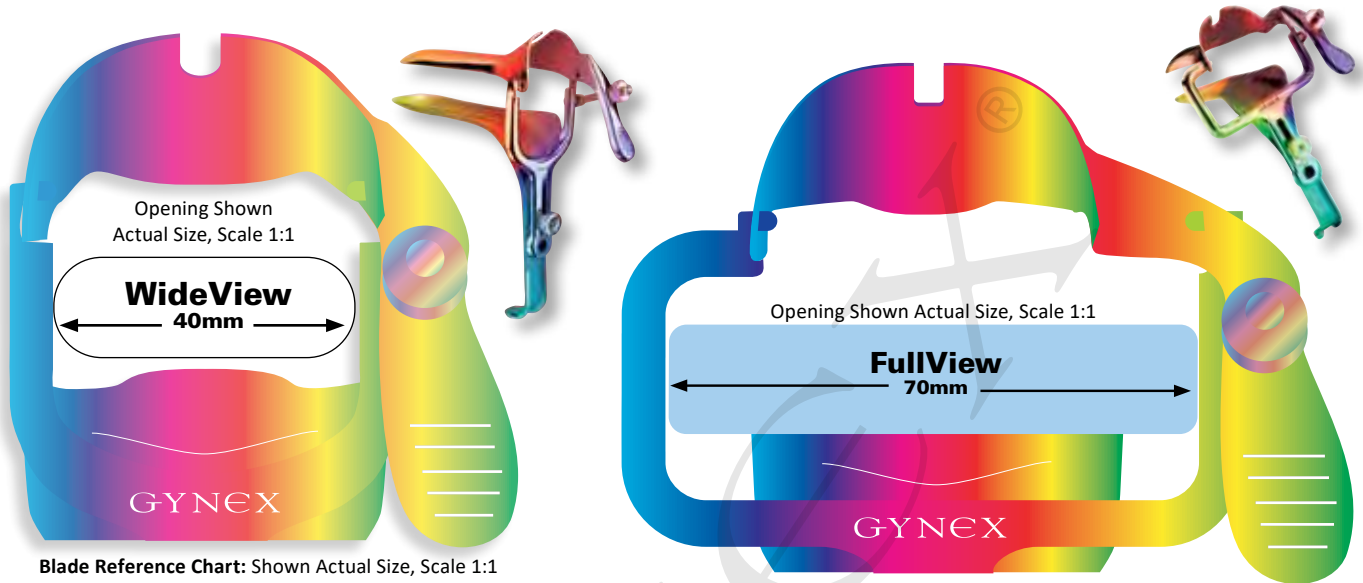

Blade Reference Chart: Shown Actual Size, Scale 1:1

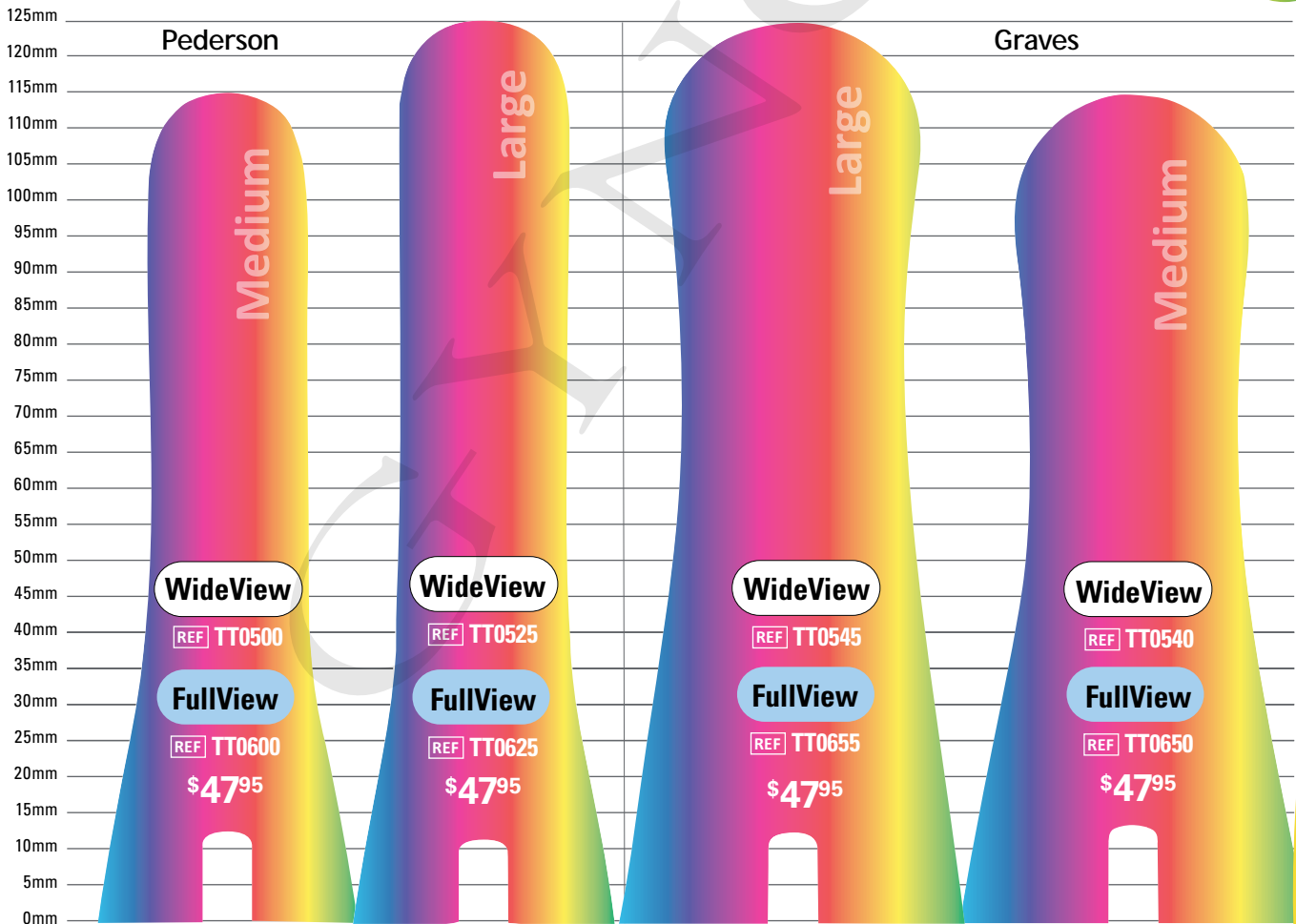

GYNEX® ULTRASONIC FETAL DOPPLER

New

Add this excellent Fetal Doppler to your practice!

Fetal Doppler Model D2500

- Highly sensitive ultrasound
- Detects heart rates of fetus as early as the 12th week
- Automatic shutdown after 1 minute without operation
- Built-in loudspeaker
- Rechargeable battery, 1180 mah lithium
- Colorful display
- 2.5MHz Ultrasound Frequency
- FHR value, FHR waveform volume
- Includes battery charger and earphones

Dimension: 215mm x 200mm x 66mm



REF D2500 \$319⁹⁵

Thermasonic Gel Warmer

- Maintains constant temperature
- Low electrical demand
- Heat indicator lamp
- Adjustable thermostat

REF D82-01 \$314⁹⁵



Doppler Gel

- Acoustically correct for the broad range of frequencies used
- Completely aqueous, will not stain clothing or damage transducers
- 250ml bottle

REF D-GEL Box of 6 ... \$40⁹⁵



pHem-Alert® Vaginal pH Test

NON-STERILE Single-Use

Not made with natural rubber latex

pHem-Alert® test measures vaginal pH, and is intended for use by women who have any of the following vaginal symptoms: Itching, Burning, Unpleasant Odor, Unusual Discharge

KEY ADVANTAGES

- Each test securely packed in a procedure blister tray
- Convenient, unique, patented applicator “key” with attached pH paper
- Easy to read pH chart included with every test set

REF pH-99 Box of 12 \$69⁹⁵



The Original Vaginal pH Test Designed for Accurate & Comprehensive Results!

- pH 4.5**
 - Normal pH
 - Predominant lactobacilli
 - Possible yeast overgrowth
 - Normal serum estradiol
- pH 5.0**
 - Low grade bacterial vaginitis
 - Borderline serum estradiol
- pH 5.5**
 - Bacterial vaginitis
 - Low serum estradiol
- pH 6.0**
 - Bacterial vaginitis
 - Low serum estradiol
- pH 6.5**
 - Bacterial vaginitis
 - Very low serum estradiol
- pH 7.0**
 - Low to no serum estradiol
- pH 7.5**
 - Low to no serum estradiol

Instrument Care and Cleaning

Touch-Guard® Hot Beads

Sterilization Beads

- Touch-Guard® Hot Beads provide a safe, effective and convenient way to sterilize surgical instruments.
- No need for potentially dangerous gases, flames, or chemicals to achieve sterilization.
- The specially cast “no-lead” glass beads transmit heat properly and remain intact at high temperatures.
- Simply plunge metal instruments into the hot glass beads for instant sterilization.
- Touch-Guard® Hot Beads are free of pathogens and microbial contaminants.
- Pre-measured containers make it easy to use the right amount of beads for each sterilization cycle.



SCAN to SHOP



REF 7106 6-Pack (6-month supply) **\$139⁹⁵**

REF 7112 12-Pack (1-year supply) **\$257⁹⁵**

Touch-Guard® Stain-Ex™

Biological & Chemical Stain Remover

- Touch-Guard® Stain-Ex™ is a fast and effective biological and chemical stain remover.
- It removes a variety of stains, including Iodine-based stains, Lugol's stain, and medical/histological stains.
- It can be used on a range of surfaces, including hands, glassware, stainless steel, plastic, counters, floors, lab coats, laboratory equipment, and hospital linen.
- Touch-Guard® Stain-Ex™ works great on LLETZ-coated instruments.
- Application is easy, and stains are removed quickly (in a matter of seconds).

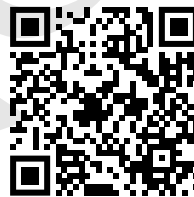

SCAN to SHOP



REF SS10 1 Gallon **\$94⁹⁵**

Touch-Guard® Low Suds

Liquid Instrument Detergent Concentrate

Touch-Guard® Low Suds Liquid Instrument Detergent Concentrate is used for effectively and safely cleaning all surgical instruments, plastic, glassware, and rubber tubing. Formulated for use in automatic washers, ultrasonics, washer-sterilizers, and manual cleaning.

- Neutral pH detergent with powerful sequestering and emulsifying agents
- Fast wetting, odorless, non-sudsing, maintains high detergency
- Removes protein, blood, tissue, fat and any organic soils
- No residue - no pyrogens; leaves a surgically clean surface
- Exceptional cleaning in hard, soft, cold or hot water
- Biodegradable; contains no phosphates or NTA
- Free rinsing, non-enzymatic formulation
- Safe for ophthalmic cleaning



SCAN to SHOP



REF TG-200 1 Gallon **\$34⁹⁵**

Touch-Guard® Lubricant

Instrument Lubricant and Rust Inhibitor

Touch-Guard® Instrument Lubricant and Rust Inhibitor protects and extends the life of all your surgical instruments. Clinically tested to be thoroughly steam penetrable, steam sterilizable and ETO sterilizable. When used daily as a rinse after cleaning, it will keep your instruments moving parts operating smoothly and remain effective even after autoclaving, without any oily residue.

- Reduces repair and replacement cost
- Prevents rust, spots, stains and corrosion
- Restores articulation to sticky box-locks and joints
- Withstands high temperatures and autoclaving
- Steam penetrable, sterilizable and ETO sterilizable
- Non-oily, non sticky, non-toxic, water-soluble and silicone free

REF TG-100 16.9 fl. oz. (500 ml) **\$19⁹⁵**



SCAN to SHOP

**FREE
SAMPLE**

To redeem your free sample,
contact us
(888) 486-4644



Instrument Repair and Sharpening

Gynex® allows you to extend the life of your instruments, deliver optimal performance and better manage your surgical asset investment. All sharpening and repairs also include rust/stain removal, cleaning, minor polishing and lubrication.

Gynex® sharpens and repairs most medical instruments. If the instrument that you would like to have sharpened or repaired is not listed here, or you have any questions, please contact us for more information.

Please note that due to metal, age and condition, some instruments may not be repairable or sharpened.

Pricing is as follows:

Gynex® Biopsy Punch	\$65⁰⁰
Other Brand Biopsy Punch	\$75⁰⁰
Gynex® Curette	\$40⁰⁰
Other Brand Curette	\$50⁰⁰

Toll Free: (888) 486-4644
(8:00AM–5:30PM CDT)

Selling Notice:

All products are limited to purchase by licensed medical practitioners, physician and medical facilities. In most cases, we do not sell to the general public.

Warranty:

All hand-held instruments in this catalog are warranted to be free of defects in manufacturing materials and workmanship for two years from date of purchase. Customers who feel an instrument is defective must return it to GYNEX for evaluation. Products found to be defective will either be repaired or replaced with the same or comparable product, at the discretion of GYNEX Customer Service. Warranty on any hand-held GYNEX instrument is voided if instrument is repaired or sharpened by anyone other than GYNEX. All GYNEX biopsy punches in this catalog will be sharpened free of charge for one year from date of purchase (if enough metal is remaining on tip to allow sharpening). Warranties do not cover general maintenance, cleaning or sharpening needs that result from normal use, except as noted above regarding biopsy punch sharpening. Damages caused by misuse, improper care, cleaning, chemicals, or loss and theft are not covered by this warranty. Shipping charges are not covered for free sharpening warranty nor extended equipment warranty.

Return Policy:

Customer must obtain a Returned Merchandise Authorization (RMA) number from GYNEX customer service at (888) 486-4644. An itemized list of returned products must accompany all returns. Include the Returned Merchandise Authorization (RMA) number and explanation of why the product is being returned. Returned goods MUST be packaged in a shipping container equivalent to that in which it was received. Returned goods MUST be shipped at customer's expense by Parcel Post, Airborne, FedEx or UPS, and must be insured for the purchase price of the contents. Returned goods received by GYNEX in any form less than that described above

will be refused by GYNEX and return shipped to the customer.

The following items may be returned:

- Product with RMA number
- All returns must be made within 30 days of the item receipt (except for warranty).
- Product with unbroken seals, with labels intact, in original container and packaging
- Unused instruments which have not been cleaned or sterilized
- Single-Use[®] product (sterile) in original, unopened package
- Product damaged in shipment*
- Product that has at least 12 months remaining shelf life as determined by the expiration date
- Instruments damaged, broken or not working properly due to defects in material or workmanship

**Note: Product returned due to error or damage in shipping must be reported to customer service within 72 hours of receipt. Damaged product must be accompanied by a written explanation noting damage.*

The following items may not be returned:

- Product without RMA number
- Product that has been improperly handled or stored
- Product that is marked, coded, dated, damaged, soiled or adulterated in any way (except standard cleaning and sterilization procedures for reusable instruments)
- Product damaged by or exposed to heat, fire, smoke, high humidity or water (except standard cleaning and sterilization procedures for reusable instruments)

Restocking Charge:

A 15% restocking charge applies to all returned product, unless the return is due to error in shipment, product damaged in shipment, or product returned for repair or replacement due to defect in material or workmanship.

Disclaimer:

All prices in this catalog are subject to change without notice. All sizes indicated may vary slightly, due to differences between manufactur-

ers. In order to carry sufficient inventory, it is necessary for GYNEX to purchase from different manufacturers. As a result, final products may not be the exact sizes as shown in charts, drawings or photos. The advertisements and information in this catalog may contain typographical errors or inaccuracies and may not be complete or current. GYNEX therefore reserves the right to correct any errors, inaccuracies, or omissions and change or update information at any time without prior notice. Please note that such errors, inaccuracies, or omissions may relate to pricing or availability. We reserve the right to refuse to honor offers or terms, which contain error or inaccuracies.

Trademark Notices:

Apex, Ascona, Ceramix, Century Uterine Manipulator/Injector, Clear-Flue, C-Safe, Direct-Access, EasyView, HexLoc, i-Series Titanium Rainbow, LiteTouch, LongView, FullView, LVR, NoSlip, New GYNeration, Opal Rainbow, Reach, Reach Extended Needle, RotoTip, Stain-Ex, Titanium Rainbow, TouchGuard, Villa, WideView, Willows and Zephyr are trademarks of GYNEX Corporation. Dennis Dilators and Galileo are registered trademarks of GYNEX Corporation. Use of these product names is limited to those with written authorization by an officer of GYNEX Corporation of North Richland Hills, Texas. ConMed and Sabre are registered trademarks of ConMed, Inc. UMI is a trademark of Thomas Medical, Inc. CooperSurgical, Shur-Lock and Euro-Med are registered trademarks of Cooper Companies. HurriCaine is a registered trademark and Snap -n- Go is a trademark of Beutlich LP, Pharmaceuticals. pHem-Alert is registered trademark of FemTek, LLC. Suresample is a registered trademark, and Portex is a trademark of Smiths Group. Z-Sampler is a trademark of BEI Medical Systems Company Inc. BEI is a registered trademark of BEI Medical Systems Company Inc. Pipelle is a registered trademark of Unimar, Inc. Utah Medical Products and Finesse are registered trademarks of Utah

Medical Products, Inc. Endocell is a trademark of Wallach Surgical Devices, Inc., and Wallach is a registered trademark of Wallach Surgical Devices, Inc. Teflon is a registered trademark of DuPont.

Force Majeure:

Neither party shall be liable for any failure or delay in delivery of goods, or in otherwise fulfilling its obligations with respect to the sale of goods to the other which results from any cause beyond its reasonable control, including disruption or delays in a common carrier's transportation schedule, compliance with any regulations, orders, acts, instructions, or priority requests of any national, state or municipal government, or any department or agency thereof, or from acts of God, fires, or other casualty of accidents, strikes, lockouts, factory shutdowns, embargoes, riots, or other disorders, delays or shortages in transportation, or inability to obtain in sufficient quantity fuel, power, labor, manufacturing facilities or materials or other supplies from the usual sources of GYNEX. Notwithstanding the foregoing, in the event a party is unable to perform as a result of such force majeure event for a period exceeding sixty (60) days, the other party may, at its option, terminate its purchase order or commitment to sell the goods and neither party shall have any further liability hereunder other than for past services rendered and goods sold.

Official Notice

ALL products are shipped from GYNEX state-of-the-art warehouse in North Richland Hills, Texas

INDEX

ACETIC ACID	5	ENDOCERVICAL		Blumenthal.....	21
Alligator Grasper, Gynex®.....	28	Curettes - Rainbow™ and Stainless	18	Jacobson.....	21
Ascona™ IUD String Snare.....	30	Kevorkian Curette, Single-Use	19	Saenger	21
Accu-Sound®.....	31	Lickerish Spiral Curettes	19	Sopher Original.....	20
BARIATRIC INSTRUMENTS		RotoCurette™.....	19	PATEL™ MULTI-USE FORCEPS	4,24
Biopsy Punches.....	6-14	Specula	16	PUNCHES	
Tissue Forceps	16	ENDOMETRIAL CURETTE AND SAMPLER		Keyes Vulvar.....	23
Specula, LLETZ Coated.....	80-81	Navak and Randall Curette (Stainless).....	17	Keyes Accessories.....	23
Specula, Stainless Steel	82-83	SURESAMPLE® <i>Select1</i> Curette.....	42-43	REPAIRS & SHARPENING SERVICE	93
BIOPSY PUNCHES		SURESAMPLE® Sampler	44-45	SCISSORS	
Amethyst.....	8	FORCEPS		IUD String.....	25
Apex™.....	14	Corson Myoma Polyp Grasping Forceps	22	Titanium Rainbow™	63
Ceramix™	6	Foerster Forceps, Stainless Steel.....	16	Zephyr™ Stainless Steel.....	63
Gold.....	9	Laminaria Insertion Forceps.....	64	Iris Stainless Steel.....	64
Kevorkian Ring Handle.....	14	Sponge Forceps, Single-Use.....	74	Littaur Stitch Scissors.....	64
Medium-Tischler.....	11	Ovum Forceps	20-21	SMOKE EVACUATION	
Mini-Tischler	10	FETAL DOPPLER - GYNEX®	90	Prefilter, Single-Use ②.....	72
Opal Rainbow™	7	GRASPER		Prefilter Reducer	72
Rose Gold	9	Alligator Grasper - GYNEX®.....	28	ULPA Filter	72
Sapphire.....	8	Serpentine Grasper.....	28	Tubing.....	73
ROTOTip™ Biopsy Punches.....	12-13	HOOKS		SPECULA	
Sullivan Ring Handle	14	LLETZ Coated.....	75	LLETZ Coated	
CARE AND CLEANING		Stainless Steel	17	4-Way Expander.....	76
Hot Glass Beads Sterilizer - Touch-Guard®.....	92	IUD INSTRUMENTS		Graves.....	80-81
Instrument Lubrication - Touch-Guard®.....	93	Ascona™ IUD String Snare.....	30	Open-Sided (left/right opening).....	77
Instrument Repair and Sharpening	93	Ceramix™ Coated String Scissors.....	25	Pedersons.....	80
Low Suds Detergent - Touch-Guard®.....	92	Crochet Type IUD Removers	29	Sullivan.....	78-79
Stain-Ex™ Stain Remover - Touch-Guard®.....	92	GYNEX® Alligator Grasper	28	Stainless Steel	
COLOSCOPES		IUD Insertion Kit, Single-Use -GYNEX®.....	30	Auvar.....	86
Galileo®.....	46-51	IUD String Scissors.....	25	Graves.....	82-83
Accessories for Galileo®.....	52	Serpentine Grasper IUD Remover	28	Greenberg.....	87
CO Series	54-59	Single-Use IUD String Scissors	28	Guttman.....	87
DILATORS		Villa™ Hormonal Dissecting Forceps.....	26	Open-Sided (left/right opening)	88
All Uterine Dilators.....	33-39	Villa™ Hormonal Implant Remover.....	27	Pederson.....	82
Dennis Dilators, Single-Use ②.....	38	Willows™ IUD String Snare, Single-Use	29	Sullivan.....	84-85
Dennis Dilators, Reusable.....	39	LATERAL VAGINAL RETRACTORS		Titanium Rainbow™	
Hank Dilators, Uterine.....	34	LLETZ.....	77	Graves.....	89
Hegar Dilators, Uterine	35	Stainless Steel.....	86	Pederson.....	89
Mini Dilators, Uterine	33	LLETZ COATED INSTRUMENTS		TABLE OF CONTENTS	1
Mini Dilators Tips, 4mm and 5mm.....	33	All Items.....	75-81	TENACULA	
Pratt Dilators, Uterine	35	Hooks.....	75	Braun	15
Small Dilators, Uterine.....	34	LVR.....	77	Schroeder	15
Soft Dilators, Single-Use ②.....	36	Speculum	77-81	Skene	16
Soft Teflon Dilators, Reusable	37	Sponge Forceps, Single-Use ②	74	Teale	16
Doppler Gel.....	90	MEDICAL EXAM LIGHT - Galileo®	60-61	TISSUE FORCEPS	16
ELECTRODES		Medical Exam Light - Accessories	60	TOPICAL ANESTHETIC - HurriCaine®	
Ball Electrode.....	67	Medical Exam Light Protective Sheath.....	61	Spray Kit.....	74
Contoured Loop Electrodes	68	Microscope - Galileo®.....	53	Swabs.....	74
Electrode Extender.....	65	MONSEL'S PASTE	5	TRANSIT MAP	96
Electrode Handpieces	65	NEEDLE ADAPTER	71	UTERINE MANIPULATOR / INJECTOR - CenturyUMI™	41
H-Series Loop Electrodes	67	NEEDLE HOLDERS		UTERINE SOUNDS	
Needle Electrode.....	67	Webster.....	64	Accu-Sound®.....	31
Radius Loop Electrode.....	66	Mayo-Hegar.....	64	Sim Sound.....	32
Triangle Loop Electrodes	68	Crile-Wood.....	64	Sim Sound • flex.....	32
Square Loop Electrodes	67	OVUM FORCEPS		VAGINAL PH TESTING - pHEM-ALERT®	91
Electrosurgical Patient Dispersive Pads.....	69	Bierer.....	21		

Transit Map

Shipping from:

6631 Browning Drive,
North Richland Hills, TX 76180



5% Discount
on Prepaid Orders
by Check or ACH Payment
(offer excludes microscopes, colposcopes and/or extended warranties).

WE ACCEPT

ONLY FOR ONLINE SHIPPING

Toll Free: (888) 486-4644
(8:00AM-5:30PM CDT)

Fax: (425) 895-0115

E-mail: service@gynex.com

Web: www.gynex.com

Terms: Net 30 Days on open approved accounts. 1.0% finance charge per month shall apply on all past due accounts. International accounts require prepayment. New accounts may require prepayment with first order.

Shipping: FOB North Richland Hills, Texas. Normal shipping via UPS or FedEx Ground, and charges for shipping and handling are added to the order total. Expedited delivery (Next Day, 2nd Day, 3rd Day) available for additional charge.

Note: Pre-paid shipping charges of \$17.50, do not apply to Alaska, Hawaii, Puerto Rico, the Virgin Islands and other U.S. Islands, international orders or orders including colposcopes and medical exam lights. An additional custom fee may apply for the Virgin Islands and other U.S. Islands, and international orders. A handling fee will apply to orders that use customer's own shipping account.

Partial Shipments: We reserve the right to make partial shipments against orders and the amounts for such partial shipments will become due and payable upon receipt unless otherwise agreed to in writing by GYNEX.

5% Discounts: Customers may deduct an additional 5% off their total order when payment is made by check or ACH at the time of purchase. Credit card payments and COD orders do not qualify for this discount. This discount does not apply to Microscopes, Colposcopes and/or extended warranties and some specials where products are already discounted. This discount cannot be combined with other discounts.

Warranties Returns and Disclaimers: All information concerning these GYNEX policies are detailed on page 94 of this catalog.

Missing Merchandise Policy: GYNEX personnel have taken great care to pack your order. Each LOT number indicated in the first column on the Packing List corresponds with and was scanned from the product packed in this box. Quantities were verified in this manner. Back orders are clearly marked, and do not have a LOT number indicated. If anything is missing from your package, the customer is responsible for notifying GYNEX within 24 hours of the customer's receipt of package.

GYNEX[®]

MAIL TO: GYNEX
 P.O. BOX 822369
 N. RICHLAND HILLS, TX 76182

MAKE A COPY OF THIS ORDER FORM, FILL IT OUT AND SEND BY FAX OR MAIL

FAX TO: (425) 895-0115

BILLING ADDRESS	SHIP TO
Name _____	Name _____
Address _____	Address _____
City _____ State _____ Zip _____	City _____ State _____ Zip _____
Email _____	Fax _____
Phone (_____) _____	Contact Person _____

REF	Qty.	DESCRIPTION	Price Each	TOTAL

<p>MAKE CHECKS PAYABLE TO:</p> <p>GYNEX CORP. PO BOX 822369 N. RICHLAND HILLS, TX 76182</p>	Total Amount Ordered	
	5% Discount for Pre-Paid Orders ONLY	
	Shipping and Handling for Pre-Paid Orders ONLY	\$17.50
	GROUND SHIPPING TO CONTINENTAL US ONLY, EXCLUDING ALASKA AND HAWAII. (Shipping charges apply for orders to Alaska and Hawaii)	
	Sales Tax	
	Total	

GYNEX®

6631 Browning Drive, North Richland Hills, TX 76180

Tel: (888) 486-4644 • Fax: (425) 895-0115
service@gynex.com • www.gynex.com

PRSRT STD
US POSTAGE
PAID
GYNEX



Add this excellent
Fetal Doppler to your practice!

see **page 90**

SCAN to SHOP



(888) 486-4644
www.gynex.com

